

Clarion®

Owner's manual & Installation manual
用户手册和安装手册

VRX835

AM/FM CD PLAYER/CD CHANGER CONTROLLER
WITH 7" LC DISPLAY

带 7 英寸液晶显示器调幅 (AM) / 调频 (FM)
CD 唱机 / CD 换片机控制器

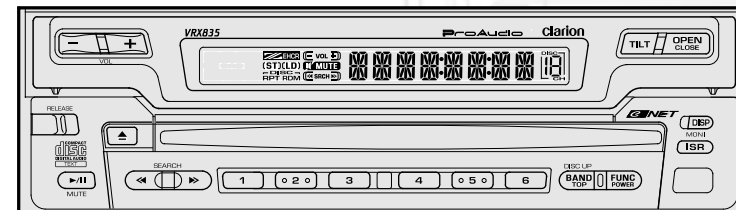

Clarion Co., Ltd.

All Rights Reserved. Copyright © 2002: Clarion Co., Ltd.

QC-6800K
280-7943-00

Thank you for purchasing the Clarion **VRX835**.

- * This owner's manual is for the **VRX835**.
- * Please read this owner's manual in its entirety before operating this equipment.
- * After reading this manual, be sure to keep it in a handy place (e.g., glove compartment).
- * Check the contents of the enclosed warranty card and keep it carefully with this manual.
- * This manual includes the operating procedures of the CD changer, MD changer, DVD changer, TV tuner, digital sound processor (DSP) and DVD video deck connected via the CeNET cable. The CD changer, MD changer, DVD changer, TV tuner, DSP and DVD video deck have their own manuals, but no explanations for operating them are described.

Contents

1. FEATURES	2
2. PRECAUTIONS	3
3. CONTROLS	5
4. NOMENCLATURE	6
5. DISPLAY	8
6. OUTLINE OF BUTTON AND TOUCHKEY OPERATION WHEN THE DISPLAY IS OPEN	10
7. REMOTE CONTROL	12
8. DCP	14
9. CAUTIONS ON HANDLING	15
10. OPERATIONS	16
Basic Operations	16
Radio Operations	20
CD Operations	22
VISUAL Operations	24
CD/MD Changer Operations	25
DVD Changer Operations	28
TV Operations	31
Other Functions	33
DSP Operations	35
DVD deck (video) Operations	41
11. IN CASE OF DIFFICULTY	42
12. ERROR DISPLAYS	44
13. SPECIFICATIONS	45

1. FEATURES

- Full-Motorized 7" Widescreen LCD
- Touch Panel Control
- Single Play CD Mechanism
- 6-Channel, 4 Volt RCA Line Level Output
- 2-AV Inputs
- Built-in 48W × 4 Amplifier
- CeNET Control
- IR Remote Control

5. DISPLAY

The Color LCD Display and the Information Panel on the main unit show the following displays, providing information about the mode and functions operated.

Information Panel

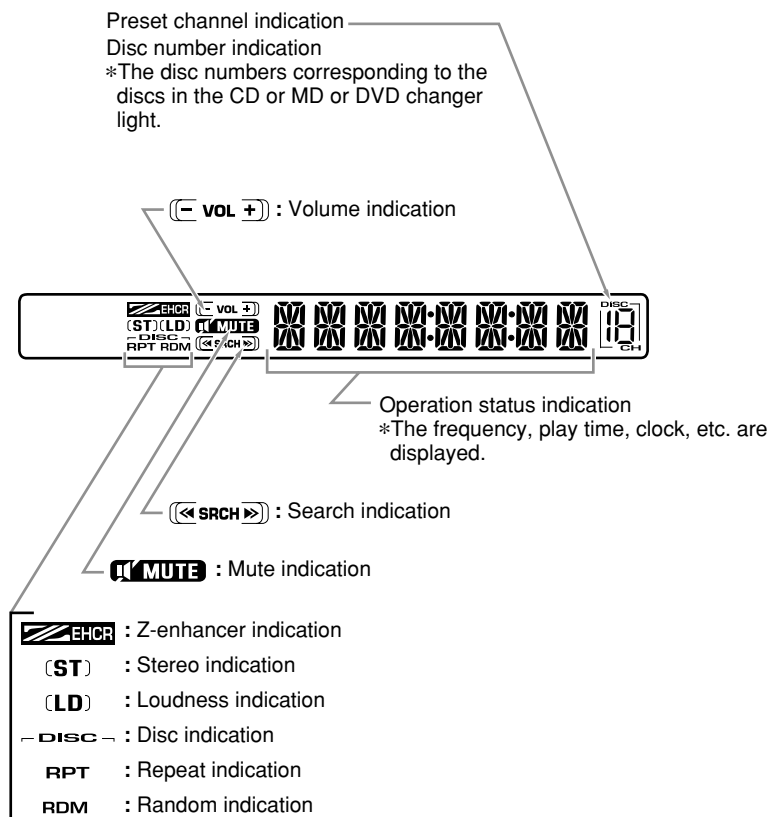

2. PRECAUTIONS

WARNING

For your safety, the driver should not watch the TV or operate the controls while driving. Please note that watching and operating the TV while driving are prohibited by law in some countries. Also, while driving, keep the volume to a level at which external sounds can be heard.

- When the inside of the car is very cold and the player is used soon after switching on the heater, moisture may form on the disc (CD/MD) or the optical parts of the player and proper playback may not be possible. If moisture forms on the disc (CD/MD), wipe it off with a soft cloth. If moisture forms on the optical parts of the player, do not use the player for about one hour. The condensation will disappear naturally allowing normal operation.
- Driving on extremely bumpy roads which cause severe vibration may cause the sound to skip.
- This unit uses a precision mechanism. Even in the event that trouble arises, never open the case, disassemble the unit, or lubricate the rotating parts.
- TV broadcast reception
 - When receiving the TV broadcasts, the strength of the signals changes since the car is moving, so in some cases it may not be possible to receive clear pictures.
 - TV signals are strongly linear, so reception is affected by buildings, mountains and other obstacles.
 - Such external factors such as electric train lines, a high voltage lines, and signal devices may disturb the picture or cause noise.
 - * If the reception is poor, switch to a station with good reception.

Caution on Handling

On CDs

- Exercise a good precaution when loading a CD disc with the panel open.
- Never turn off the power and remove the unit from the car with a CD loaded.

Handling Compact Discs

Use only compact discs bearing the  mark.

Do not play heart-shaped, octagonal, or other specially shaped compact discs. Some CDs recorded in CD-R mode may not be usable. Even when recorded in CD-RW mode, some CDs not be usable.

Handling

- New discs may have some roughness around the edges. If such discs are used, the player may not work or the sound may skip. Use a ball-point pen or the like to remove any roughness from the edge of the disc.

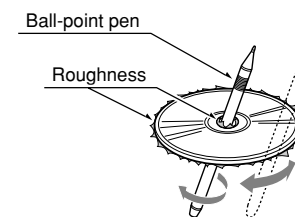

- Never stick labels on the surface of the compact disc or mark the surface with a pencil or pen.
- Never play a compact disc with any cellophane tape or other glue on it or with peeling off marks. If you try to play such a compact disc, you may not be able to get it back out of the CD player or it may damage the CD player.
- Do not use compact discs that have large scratches, are misshapen, cracked, etc. Use of such discs may cause misoperation or damage.
- To remove a compact disc from its storage case, press down on the center of the case and lift the disc out, holding it carefully by the edges.
- Do not use commercially available CD protection sheets or discs equipped with stabilizers, etc. These may damage the disc or cause breakdown of the internal mechanism.

Storage

- Do not expose compact discs to direct sunlight or any heat source.
- Do not expose compact discs to excess humidity or dust.
- Do not expose compact discs to direct heat from heaters.

Cleaning

- To remove fingermarks and dust, use a soft cloth and wipe in a straight line from the center of the compact disc to the circumference.
- Do not use any solvents, such as commercially available cleaners, anti-static spray, or thinner to clean compact discs.
- After using special compact disc cleaner, let the compact disc dry off well before playing it.

Be sure to unfold and read the next page.

请务必打开并阅读下一页。

3. CONTROLS / 控制部分

Main unit / 主机

With the Display closed / 显示屏处于关闭状态

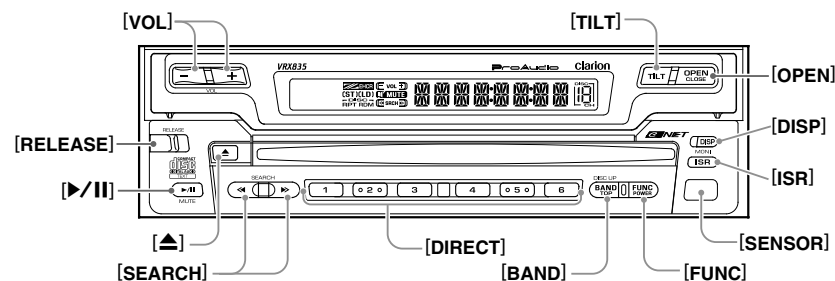

With the Display open / 显示屏处于打开状态

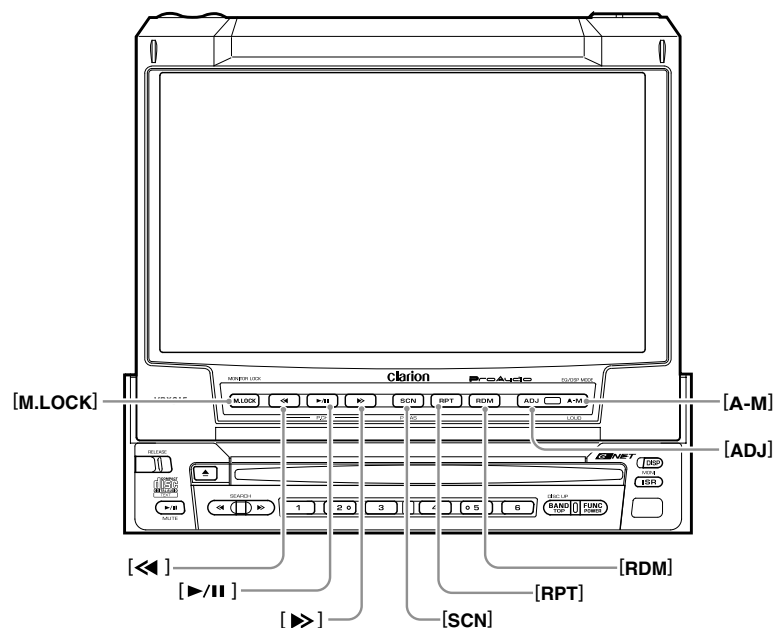

Note: Be sure to unfold this page and refer to the front diagrams as you read each chapter.
注意: 在阅读每一章时, 请务必打开本页, 并参照本页的前视图。

4. NOMENCLATURE

Names of Buttons

Note:

• Be sure to read this chapter referring to the front diagrams of chapter "3. CONTROLS" on page 5 (unfold).

When the display closed

[VOL] button

- Use this button to increase/decrease the volume.

[TILT] button

- Use this button to adjust the angle of the liquid crystal panel in 5 steps.
- Every time this button is pressed and held for about 2 seconds or longer, the liquid crystal panel moves forward/backward in 3 steps.

[OPEN] button

- Use this button to open/close the liquid crystal panel.
- Press and hold this button for about 2 seconds or longer so that the liquid crystal panel is positioned horizontally when the liquid crystal panel is open. Press the button again to return the panel to the original position. Even if the button is not pressed, the panel returns to the original position after about 10 seconds.

[DISP] button

- Use this button to switch the indications such as play status on the information panel when the liquid crystal panel is closed.
- Use this button to call the LCD background screen setup menu when the liquid crystal panel is open.
- Press and hold this button for 1 second or longer to turn off the monitor when the liquid crystal panel is open.
- Use this button to switch the display sizes while in the screen where the TV, VISUAL, or DVD video, DVD changer mode is suspended.

[ISR] button

- Use this button to enter the ISR (Instant station recall) standby mode.

[SENSOR]

- Remote control infrared sensor

[FUNC] button

- Press this button to turn on the power. Press and hold this button for 1 second or longer to turn off the power.
- Press this button to switch the modes such as radio.

[BAND] button

- Press this button to switch the receiving bands for radio/TV mode, etc. Press and hold this button for 1 second or longer to switch the SEEK/MANUAL tuning modes.
- Use this button to move to the first track on a disc in the CD mode.
- Use this button to switch to the next disc in the CD/MD/DVD changer mode.

[DIRECT] button

- Use this button to select a preset channel in the radio/TV mode.
- Use this button to select a disc in the CD/MD/DVD changer mode.

[SEARCH] button

- Use this button to tune to a station in the radio/TV mode.
- Use this button to select a track in the CD/DVD video mode and CD/MD/DVD changer mode.

[▲] button

- Use this button to eject a CD.

[▶/||] button

- Use this button to mute the sound.
- Press and hold this button for 1 second or longer to enter the play pause mode in the CD/DVD video mode and CD/MD/DVD changer mode. Press and hold the button for 1 second or longer again to resume playback.

[RELEASE] button

- Use this button to remove the DCP from the main unit.

When the display open

[A-M] button

- Shows the AUDIO MODE menu for tone adjustment, etc. Press and hold this button for 1 second or longer to switch the loudness on or off (LOUD ON/OFF).

[ADJ] button

- Shows the ADJUST MODE menu to change the settings.

[RDM] button

- Performs random play while in the CD mode or CD/MD/DVD changer mode. Also performs disc random play when the button is pressed and held while in the CD/MD/DVD changer mode.

[RPT] button

- Plays repeatedly while in the CD mode or CD/MD/DVD changer mode. When this button is pressed and held while in the CD/MD/DVD changer mode, disc repeat play is performed.

[SCN] button

- Performs preset scan while in the radio mode. When the button is pressed and held, auto store is performed.
- Performs scan play for 10 seconds for each track while in the CD mode and CD/MD/DVD changer mode. Disc scan play is performed when the button is pressed and held while in the CD/MD/DVD changer mode.

[◀▶] button

- Use this button to select a track in the CD/DVD video mode and CD/MD/DVD changer mode.

[▶/||] button

- Press to enter the play pause mode in the CD/DVD video mode and CD/MD/DVD changer mode. Press to resume playback.

[M.LOCK] button

- The display panel can be switched to a composite screen to lock the monitor.

- Radio/TV mode
: **PROGRAM ▶ WEST COAST** (User title)
- CD/CD changer mode
: **USER TITLE ▶ SHINE** (User title)
- CD TEXT mode
: **DISC TITLE ▶ SHINE** (Disc title)
: **TRACK TITLE ▶ Time has come** (Track title)
: **ARTIST ▶ Time has come** (Artist)
- MD changer mode
: **DISC TITLE ▶ SHINE** (Disc title)
: **TRACK TITLE ▶ Time has come** (Track title)

- Radio mode : **FM1 100.00MHz Pch 1** (Band/Frequency/Preset No.)
- CD mode : **TRACK 02 04 : 07** (Track No./Playback time)
- CD/MD changer mode
: **DISC 02 TRACK 02 00 : 45** (Disc No./Track No./Playback time)
- TV mode : **TV1 28CH Pch 1** (Band/Channel/Preset No.)
- VISUAL mode : **VISUAL 1** (Band)
- DVD mode : **CHAPTER 01** (Chapter No.)
- DVD changer mode
DVD-video : **D2 T02 C002 01:00:45**
(Disc No./Title No./Chapter No./Playback time)
Video CD : **D2 T02 01:00:45** (Disc No./Track No./Playback time)
MP3 : **D2 F001 T002 00:45**
(Disc No./Folder No./Track No./Playback time)
CD : **D2 T02 00:45** (Disc No./Track No./Playback time)



MOTION/SPRITE pattern display

Clock time

Mode name

- **MANU** : Seek/Manual indication
- **ST** : Stereo indication
- **LD** : Loudness indication
- **ZEHCR** : Z-enhancer indication

6. OUTLINE OF BUTTON AND TOUCHKEY OPERATION WHEN THE DISPLAY IS OPEN

*1

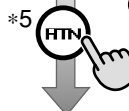
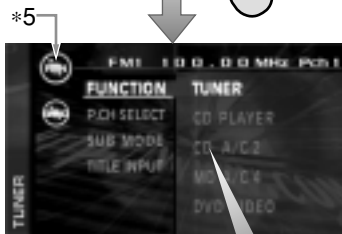
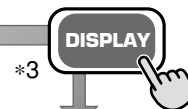
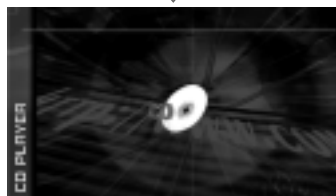

*1: An example screen indication in the radio mode

*2: Press an operation button to switch the screen.
The operation button is **[FUNC]** button in the description of operation per mode.

*3: Touch the screen and the menu corresponding to the play mode is displayed.

*4: Touch an operation key to switch the screen.
The operation key is **[FUNCTION]** key in the description of operation per mode.

*5: Touch the **[RTN]** key to return to the previous screen.

*6: Touch the **[▲]** key to return to the previous menu.

*7: Touch the **[▼]** key to go to the next menu.

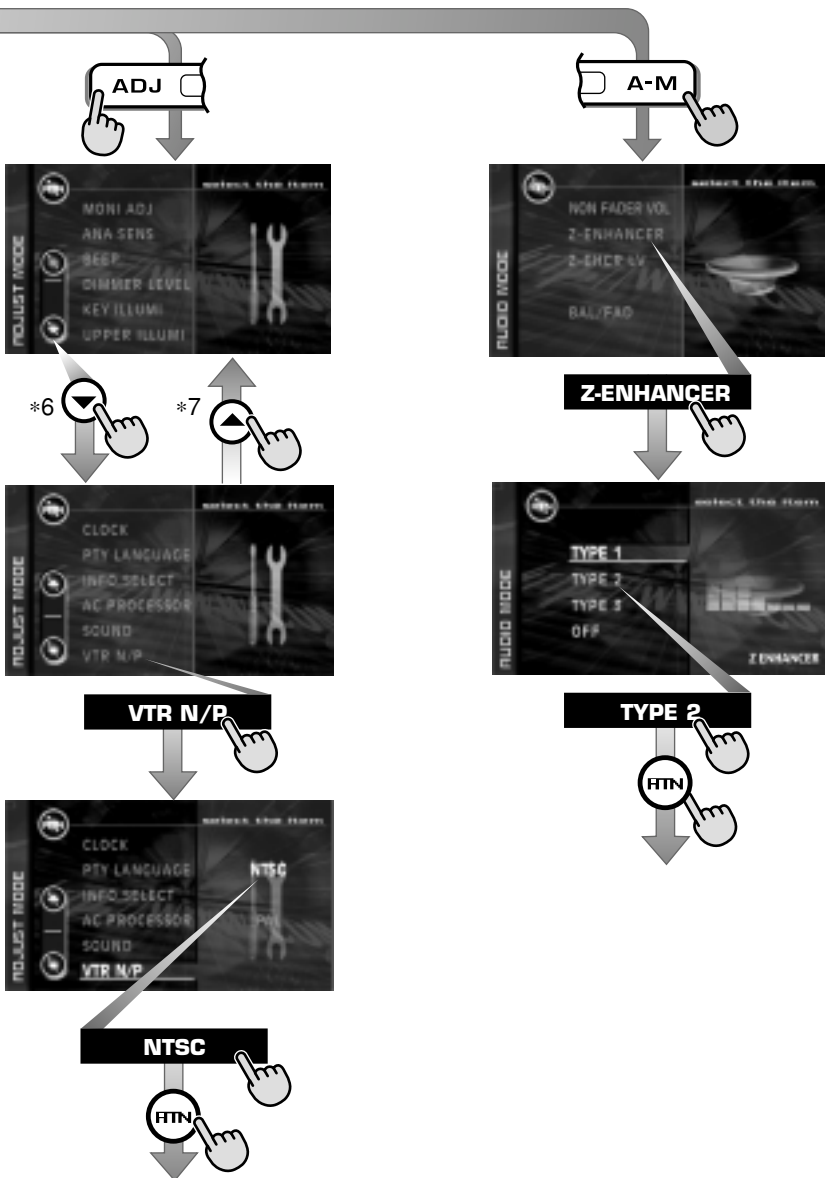

7. REMOTE CONTROL

When the panel is open

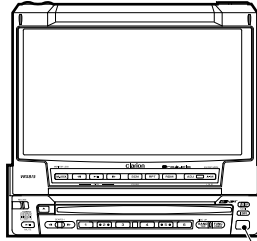

Receiver for remote control unit

Remote control unit

Operating range: 30° in all directions

Signal transmitter

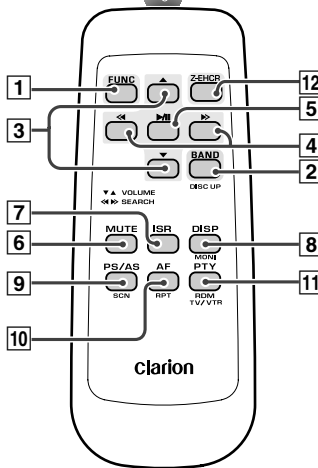

Inserting the Batteries

1. Turn the remote control unit over, then slide the rear cover in the direction of the arrow.
2. Insert the AA (SUM-3, IECR-6/1.5V) batteries that came with the remote control unit facing in the directions shown in the figure, then close the rear cover.

Notes:

Using batteries improperly can cause them to explode. Take note of the following points:

- When replacing batteries, replace both batteries with new ones.
- Do not short-circuit, disassemble or heat batteries.
- Do not dispose of batteries into fire or flames.
- Dispose of spent batteries properly.

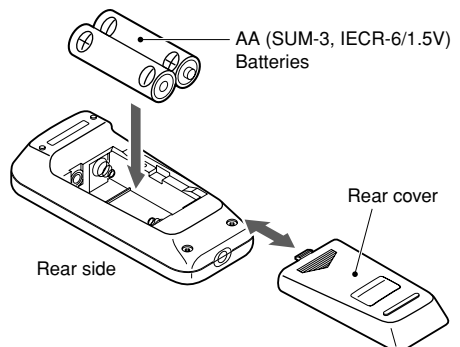

Functions of Remote Control Unit Buttons

Mode Button	Radio	CD	DVD changer CD changer MD changer	TV
1 FUNC	Switches among radio, CD, DVD, CD changer, MD changer, DVD changer, TV and VISUAL. Power OFF; Press and hold for 1 second or longer.			
2 BAND DISC UP TOP	Switches reception band.	Plays the first track. Top play.	Moves the next disc in increasing order.	Switches reception band.
3 VOLUME	Increases and decreases volume (in all modes).			
4 SEARCH	Moves preset channels up and down.	Moves tracks up and down. When pressed and held for 1 second: Fast-forward/fast-backward.	Moves tracks up and down. When pressed and held for 1 second: Fast-forward/fast-backward.	Moves preset channels up and down.
5 PLAY/PAUSE	No function.	Switches between playback and pause.	Switches between playback and pause.	No function.
6 MUTE	Turns mute on and off.			
7 ISR	Recalls ISR radio station in memory. Press and hold for 2 seconds or longer: Stores current station into ISR memory (radio mode only).			
8 DISP WIDE	When the display open, Display mode select. When the display open and when pressed and held for 1 second: Turns on and off the monitor. (When the unit is in the DVD changer mode and the vehicle is moving, operates in the same way on the CD/MD changer. When the vehicle is stopped, changes the screen size. When pressed and held: Turns on and off the monitor.)			Switches the TV mode.
	When the display close, Switches among main-display, sub-display, clock-display.*1			
9 PS/AS SCN	Preset scan. When pressed and held for 2 seconds: Auto store.	Scan play.	Scan play. When pressed and held for 1 second: Disc scan play.	Preset scan. When pressed and held for 2 seconds: Auto store.
10 AF RPT	No function.	Repeat play.	Repeat play. When pressed and held for 1 second: Disc repeat play.	No function.
11 PTY RDM TV/VTR	No function.	Random play.	Random play. When pressed and held for 1 second: Disc random play.	Switches between TV and VTR.
12 Z-EHCR	Switches Z-ENHANCER 1, 2, 3, OFF			

Notes:

- Some of the corresponding buttons on the main unit and remote control unit have different functions.
- Please use the dedicated remote control unit provided with a DVD player in the DVD mode or DVD changer in the DVD changer mode.

*1: No sub-display appears when the unit is in the DVD changer mode.

8. DCP

The control panel can be detached to prevent theft. When detaching the control panel, store it in the DCP (DETACHABLE CONTROL PANEL) case to prevent scratches.

We recommend taking the DCP with you when leaving the car.

Removing the DCP

1. Turn the power off.
2. Slide the **[RELEASE]** lever rightward to release the DCP/Operation Panel.

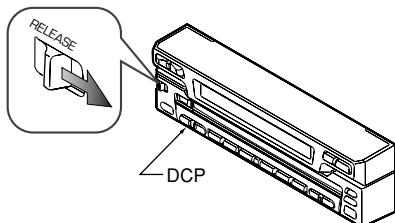

3. Pull the DCP toward you and remove it.

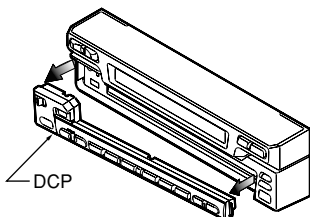

Attaching the DCP

1. Insert the DCP so that the **(A)** section on the right side of the DCP catches on the hook **(B)** on the unit.

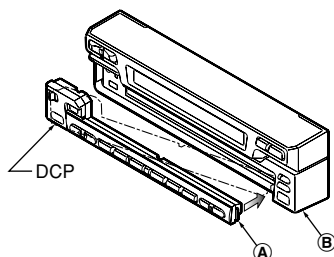

2. Press the left side of the DCP carefully to fit it in place.

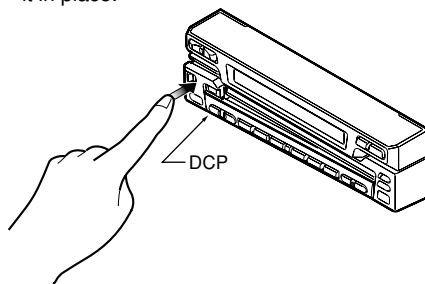

3. Press the **[FUNC]** button to turn on the power.

CAUTION

- The DCP can easily be damaged by shocks. After removing it, be careful not to drop it or subject it to strong shocks.
- If the Operation Panel is kept open, the DCP may drop due to vibration of the car. This results in damage to the DCP. So close the Operation Panel or remove the DCP to store into the case.
- The DCP is an extremely important part. Be careful not to damage it by pressing on it with fingernails, screwdrivers, etc.

Note:

- If the DCP is dirty, wipe off the dirt with a soft, dry cloth only.

9. CAUTIONS ON HANDLING

LCD panel/Generalities

For a longer service life, be sure to read the following cautions.

- Be sure to store the LCD panel inside the main unit when parking the car outdoors for long period of time. The LCD panel will operate properly in a temperature range of 0 to 60°C.
- Don't allow any liquids on the set from drinks, umbrellas etc. Doing so may damage the internal circuitry.
- Do not disassemble or modify the set in any way. Doing so may result in damage.
- Do not draw the LCD panel out and use it as a tray. Also, subjecting the LCD panel to shocks may result in breakage, deformation or other damage.
- Do not let cigarettes burn the display. Doing so may damage or deform the cabinet.
- If a problem should occur, have the set inspected at your store of purchase.
- Do not insert objects or poke in the space between the LCD panel and the main unit when the panel is tilted.
- Do not place anything on the display when the panel is tilted.
- The remote controller may not work if the remote control sensor is exposed to direct sunlight.
- In extremely cold weather, the display movement may slow down and the display may darken, but this is not a malfunction. The display will work normally when the temperature increases.
- Small black and shiny spots inside the LCD panel are normal for LCD products.
- The LCD panel may stop temporarily when it opens or closes, when the engine stops or when it is cold.
- The touchkeys on the display operate when slightly touched. Do not press the touchkey screen with much force.
- Do not push the case surrounding the touchkey panel with much force. This may cause malfunctioning of the touchkeys.

Cleaning

• Cleaning the cabinet

Use a soft, dry cloth and gently wipe off the dirt. For tough dirt, apply some neutral detergent diluted in water to a soft cloth, wipe off the dirt gently, then wipe again with a dry cloth.

Do not use benzene, thinner, car cleaner, etc., as these substances may damage the cabinet or cause the paint to peel. Also, leaving rubber or plastic products in contact with the cabinet for long periods of time may cause stains.

• Cleaning the LCD panel

The LCD panel tends to collect dust, so wipe it off occasionally with a soft cloth. The surface is easily scratched, so do not rub it with hard objects.

10. OPERATIONS

Basic Operations

Note: Be sure to read this chapter referring to the front diagrams of chapter "3. CONTROLS" on page 5 (unfold).

⚠ CAUTION

When the unit is turned on, starting and stopping the engine with its volume raised to the maximum level may harm your hearings. Be careful about adjusting the volume.

Note:

- Use this unit after starting the engine.



ACC or engine
ON position

Turning on and off the power

Note:

- Be careful about using this unit for a long time without running the engine. If you drain the car's battery too far, you may not be able to start the engine and this can reduce the service life of the battery.

1. Press the [FUNC] button.
2. The illumination and display on the unit light up. The unit automatically remembers its last operation mode and will automatically switch to display that mode.
3. Press and hold the [FUNC] button for 1 second or longer to turn off the power for the unit.

Note:

- About the "SYSTEM CHECK"
The confirmation of connected equipment must be performed for this unit only when the wiring connection is complete and power is turned on to the unit first. When the power is supplied, "SYSTEM" and "PUSH PWR" appear alternately in the display. Press the [FUNC] button, the system check starts inside the unit. When "COMPLETE" appears, press once again the [FUNC] button.

Selecting a mode

1. Press the [FUNC] button to change the mode of operation.
2. Each time you press the [FUNC] button, the mode of operation changes in the following order:
Radio mode → CD mode → DVD video mode → CD changer mode → MD changer mode → DVD changer mode → TV mode → VISUAL mode → Radio mode...
* External equipment not connected with CeNET is not selected.

Adjusting the volume

Operate the [VOL] button in the direction of the + (up) or - (down) to adjust the volume;

- + : Increases the volume.
- : Decreases the volume.

* The volume level indicated in the display is in a range from 0 (minimum) to 33 (maximum).

⚠ CAUTION

While driving, keep the volume at a level at which external sounds can be heard.

Switching the display

When the panel is closed:

Press the [DISP] button to select the desired display.

Each time you press the [DISP] button, the display switches in the following order:

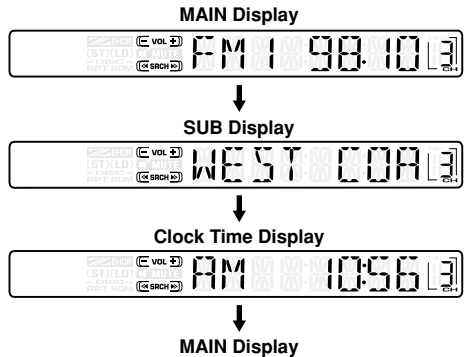

Notes:

- Once selected, the preferred display becomes the default display. When a function adjustment such as volume is made, the display momentarily switches to that function's display, then returns back to the preferred display several seconds after the adjustment.
- If a title has been input, it is shown in the SUB display. If no title has been input, "NO TITLE" appears in the display. To input a title, refer to the subsection "Entering titles" in "Other Functions" section.
- For CD, MD and TV, some special characters of the title will not be displayed on the Information Panel of the DCP. In this case, those characters will only be left blank.
- No sub-display appears when the unit is in the DVD changer mode.

Showing a mode display

When the panel is open:

Touch the menu screen switching touchkey when the main screen is being displayed to show the menu screen.

Touch the Title List Select key (--- SELECT) on the menu screen to show the Title List display.

In the Title List display, the titles of items stored in the [DIRECT] buttons 1 to 6 are listed.

Opening and turning the display

⚠ WARNING

- To prevent the battery from going dead, operate this unit with the engine running, if possible.
- When the liquid crystal panel is operating, be careful not to get your hand or finger caught between the panel and main unit or the instrument panel of the car.

Standing up the liquid crystal panel

Press the [OPEN] button and the liquid crystal panel comes out and stand up automatically.

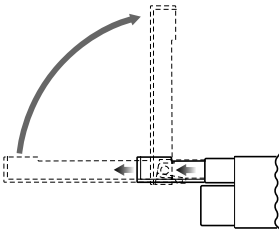

* While the liquid crystal panel is opening or closing, the LED blinks.

Note:

- If the liquid crystal panel stops in the middle of its operation, press the [OPEN] button to house the panel and press the button again to stand it up. The unit enters the same display mode as the display was turned off the last time.

Adjusting the angel, etc. of the liquid crystal panel

The angle of the liquid crystal panel or protruding amount of the panel from the mounting surface can be adjusted depending on the mounting angle of the unit or light coming into the car.

To adjust the angle

Every time the [TILT] button is pressed, the liquid crystal panel tilts forward or backward at up to about 20 degrees. The adjusted angel is stored in memory.

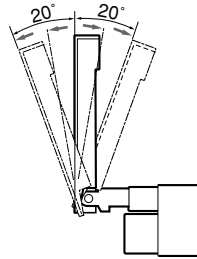

Note:

- Do not move the liquid crystal panel by hand.

To adjust the slide position

Press and hold the [TILT] button and release when a beep is heard.

The liquid crystal panel slides forward or backward. The adjusted slide position is stored in memory.

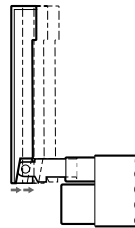

Housing the liquid crystal panel

Press the [OPEN] button and the liquid crystal panel is housed automatically.

Note:

- When leaving this unit unused for a long period of time or leaving your car, be sure to house the liquid crystal panel into the main unit.

Basic Operations

Turning the liquid crystal panel horizontal (Air conditioner operation mode)

When the way the liquid crystal panel is mounted hinders the operation of the air conditioner, the position of the panel can be turned horizontal temporarily.

1. Press and hold the **[OPEN]** button when the liquid crystal panel is upright, and release the button when a beep is heard.
2. The liquid crystal panel turns horizontal.
 - * Press the **[OPEN]** button again when the liquid crystal panel is in the horizontal position, and the panel returns to the original position.
 - * Even if the button is not operated for about 10 seconds, the panel returns to the original position with a warning sound.

Turning on and off the monitor

Pressing and holding the **[DISP]** button for 1 second or longer turns the monitor off. To return to the monitor on, press the **[DISP]** button once again.

* When a button is pressed or during security monitoring, the monitor-off mode is canceled.

Mute

Each time you press the **[MUTE]** button, mute is turned on and off.

"MUTE" appears when mute is turned on.

Setting the Z-enhancer

This unit comes with 3 types of sound tone effect stored in memory. Select the one you prefer.

* The factory default setting is "Z-EHCR OFF".

When a Z-enhancer comes on (1-3), "Z-EHCR" appears in the display.

- "Z-EHCR 1" (Z-Enhancer 1):
Setting emphasizing bass.
- "Z-EHCR 2" (Z-Enhancer 2):
Setting emphasizing treble.
- "Z-EHCR 3" (Z-Enhancer 3):
Setting emphasizing bass and treble.
- "Z-EHCR OFF" (Z-Enhancer off):
Neither bass nor treble are emphasized by the Z-enhancer.

Note:

- Incapable of operation when connecting DSP (DPH910) and DVD player (DVS9755z).

When the panel is closed:

Each time you press the **[Z-EHCR]** button of the remote control unit, the tone effect changes in the following order:

"Z-EHCR 1" → "Z-EHCR 2" → "Z-EHCR 3" → "Z-EHCR OFF" → "Z-EHCR 1" ...

Note:

- When the panel is closed, operations can only be made through the remote control unit.

When the panel is open:

1. Press the **[A-M]** button to change into the AUDIO-MODE display.
2. Touch the **[Z-ENHANCER]** key when the AUDIO-MODE screen is being displayed to show the Z-ENHANCER type selection screen.
3. When the Z-ENHANCER type selection screen is displayed, touch the key for the desirable type to select it.
 - "TYPE 1" (Z-Enhancer 1)
 - "TYPE 2" (Z-Enhancer 2)
 - "TYPE 3" (Z-Enhancer 3)
 - "OFF" (Z-Enhancer off)
4. When the setting is finished, touch the **[RTN]** key to return to the AUDIO-MODE screen.
Touch the **[RTN]** key on the AUDIO-MODE screen to return to the STANDARD display.
 - * To return from the Z-ENHANCER type selection display to the STANDARD display, press the **[A-M]** button once again.

Adjusting the Z-enhancer

Notes:

- The Z-enhancer cannot be adjusted when it is turned off.
 - This function is enabled only when the panel is open.
1. Press the **[A-M]** button to change into the AUDIO-MODE display.
 2. Touch the **[Z-EHCR LV]** key when the AUDIO-MODE screen is being displayed to show the Z-ENHANCER level adjustment screen.
 3. Touch the **[▲]** or **[▼]** key to adjust to the desirable level.
 - * When type 1 is selected, you can adjust the bass in the range of ± 2 .
 - * When type 2 is selected, you can adjust the treble in the range of ± 2 .
 - * When type 3 is selected, you can adjust the bass and treble in the range of ± 2 .
 4. When adjustment is finished, touch the **[RTN]** key on the Z-ENHANCER level adjustment

screen to return to the AUDIO-MODE screen.

Touch the **[RTN]** key on the AUDIO-MODE screen to return to the STANDARD display.

- * To return from the Z-Enhancer level mode display to the STANDARD display, press the **[A-M]** button once again.

Adjusting the bass and treble

Notes:

- This function is enabled only when the panel is open.
- This function can be adjusted only when the Z-enhancer is OFF.

1. Press the **[A-M]** button to change into the AUDIO-MODE display.
2. Touch the **[BAS/TREB]** key when the AUDIO-MODE screen is being displayed to show the BASS/TREBLE LEVEL adjustment screen.
3. Touch the **[▲]** or **[▼]** key to adjust to the desirable BASS/TREBLE level (adjustment range: from -6 to 6).
4. When adjustment is finished, touch the **[RTN]** key on the BASS/TREBLE LEVEL adjustment screen to return to the AUDIO-MODE screen.

Touch the **[RTN]** key on the AUDIO-MODE screen to return to the STANDARD display.

- * To return from the BASS/TREBLE LEVEL mode display to the STANDARD display, press the **[A-M]** button once again.

Adjusting the balance and fader

Note:

- This function is enabled only when the panel is open.

1. Press the **[A-M]** button to change into the AUDIO-MODE display.
2. Touch the **[BAL/FAD]** key when the AUDIO-MODE screen is being displayed to show the BALANCE/FADER adjustment screen.
3. Touch the **[▶]** or **[◀]** key to adjust to the desirable balance.

Adjusting range of the balance: left 13 to right 13

4. Touch the **[▲]** or **[▼]** key to adjust to the desirable fader.

Adjusting range of the fader: front 12 / rear 12

5. When adjustment is finished, touch the **[RTN]** key on the BALANCE/FADER adjustment screen to return to the AUDIO-MODE screen. Touch the **[RTN]** key on the AUDIO-MODE screen to return to the STANDARD display.
 - * To return from the BALANCE/FADER mode display to the STANDARD display, press the **[A-M]** button once again.

Turning on/off the loudness

The loudness effect emphasizes the bass and treble to create a natural sound tone. When you are listening to music at a low volume, it is recommended to use the loudness effect.

- * This function is enabled only when the panel is open.

1. Press the **[A-M]** button for 1 second or longer to select Loudness ON. The “LD” indicator lights in the display.
2. Press the **[A-M]** button for 1 second or longer to select Loudness OFF. The “LD” indicator goes off.

Note:

- When using a sold separately digital sound processor (DPH910) or DVD player (DVS9755z), a feature called auto loudness is selected. This function is different from the loudness effect. For further details on the auto loudness feature, refer to the subsection “Output adjustment of auto loudness, subwoofer and playback band”.

Changing the setting of the display background

⚠ WARNING

Perform the setting of this function the car is stopped with the parking break applied.

1. Press the **[DISP]** button to show the background setup menu.
2. Touch the setting key to show the setup display.
 - **To set up the pattern and colour of the wall paper**
 - 2-1. Touch the **[WALL PAPER]** key to select “PATTERN” or “COLOR”.
 - 2-2. Touch the **[PATTERN]** or **[COLOR]** key to set a desired pattern or colour.
 - 2-3. Touch a desired **[PATTERN]** or **[COLOR]** key.
 - **To set up the motion pattern**
 - 2-1. Touch the **[MOTION PATTERN]** key to set a desired motion pattern.
 - 2-2. Touch a desired **[MOTION PATTERN]** key.
 - **To set up the sprite pattern**
 - 2-1. Touch the **[SPRITE PATTERN]** key to set a desired sprite pattern.
 - 2-2. Touch a desired **[SPRITE PATTERN]** key.
3. Press the **[DISP]** button again or touch the **[RTN]** key two times to return to the STANDARD display.

Radio Operations

FM reception

For enhanced FM performance the **MAGI-TUNEEZ**® tuner includes signal actuated stereo control, Enhanced Multi AGC, Impulse noise reduction circuits and Multipath noise reduction circuits.

Changing the reception area

This unit is initially set to outside USA frequency intervals of 9kHz for AM and 50kHz for FM. When using it in the USA, the frequency reception range can be switched to the intervals below.

● Setting the reception area

While pressing **[DISP]** button, each time you press and hold the number "6" of the **[DIRECT]** buttons for 2 seconds or longer, the reception area switches from inside the USA to outside the USA or from outside the USA to inside the USA.

* Any station preset memories are lost when the reception area is changed.

Listening to the radio

1. Press the **[FUNC]** button and select the RADIO mode. The frequency is displayed.
2. Press the **[BAND]** button and select the radio band. Each time the button is pressed, the radio reception band changes in the following order:
FM1 → FM2 → FM3 → AM → FM1...
3. Press the right (▶▶) or left (◀◀) side of the **[SEARCH]** button to tune in the desired station.

Tuning

There are 3 types of tuning mode available, seek tuning, manual tuning and preset tuning.

Seek tuning

1. Press the **[BAND]** button and select the desired band. (FM or AM)
2. Tune in to a station.
 - * If "MANU" is lit in the display (or when the panel is closed, if the indication "SRCH" is not lit) press and hold the **[BAND]** button for 1 second or longer. "MANU" in the display goes off (or when the panel is close the indication "SRCH" lights) and seek tuning is now available.

3. Press the right (▶▶) or left (◀◀) side of the **[SEARCH]** button to automatically seek a station.

When the right (▶▶) side of the **[SEARCH]** button is pressed, the station is sought in the direction of higher frequencies; when the left (◀◀) side of the **[SEARCH]** button is pressed, the station is sought in the direction of lower frequencies.

Manual tuning

There are 2 ways available: Quick tuning and step tuning.

When you are in the step tuning mode, the frequency changes one step at a time. In quick tuning mode, you can quickly tune the desired frequency.

1. Press the **[BAND]** button and select the desired band. (FM or AM)
 - * If "MANU" is not lit in the display (or when the panel is closed, if the indicator "SRCH" is lit), press and hold the **[BAND]** button for 1 second or longer. "MANU" appears in the display (or when the panel is closed, the indicator "SRCH" goes off) and manual tuning is now available.
2. Tune into a station.

● Quick tuning:

Press and hold the right (▶▶) or left (◀◀) side of the **[SEARCH]** button for 1 second or longer to tune in a station.

● Step tuning:

Press the right (▶▶) or left (◀◀) side of the **[SEARCH]** button to manually tune in a station.

Recalling a preset station

A total of 24 preset positions (6-FM1, 6-FM2, 6-FM3, 6-AM) exists to store individual radio stations in memory. Pressing the corresponding **[DIRECT]** button recalls the stored radio frequency automatically.

1. Press the **[BAND]** button and select the desired band. (FM or AM)
2. Press the corresponding **[DIRECT]** button to recall the stored station.
 - * Press and hold one of the **[DIRECT]** buttons for 2 seconds or longer to store that station into preset memory.
 - * When the panel is open, the same operation is also available by using the [◀◀] and [▶▶] button in the panel.

Radio Operations

Manual memory

1. Press the **[BAND]** button and select the desired band. (FM or AM)
2. Select the desired station with seek tuning, manual tuning, or preset tuning.
3. Press and hold one of the **[DIRECT]** buttons for 2 seconds or longer to store the current station into preset memory.

Auto store

Auto store is a function for storing up to 6 stations that are automatically tuned in sequentially. If 6 receivable stations cannot be received, a previously stored station remains unoverwritten at the memory position.

1. Press the **[BAND]** button and select the desired band. (FM or AM)
2. Touch the MENU display switching touchkey when the MAIN display is showing and the MENU display appears.
3. Touch the **[SUB MODE]** key in the MENU display and the **[AUTO STORE]** key appears in the display.
4. Touch and hold the **[AUTO STORE]** key for 2 seconds or longer.

The stations with good reception are stored automatically to the preset channels.

* The same operation is also available by using the **[SCN]** button for 1 second or longer in the panel.

Preset scan

Preset scan receives the stations stored in preset memory in order. This function is useful when searching for desired station in memory.

1. Touch the MENU display switching touchkey when the MAIN display is showing and the MENU display appears.
2. Touch the **[SUB MODE]** key in the MENU display and the **[PRESET SCAN]** key appears in the display.
3. Touch the **[PRESET SCAN]** key to start preset scan.
4. When the desired station is turned in, touch the **[PRESET SCAN]** key again to continue receiving that station.

* The same operation is also available by using the **[SCN]** button in the panel.

Instant station recall (ISR)

Instant station recall is a special radio preset that instantly accesses a favorite radio station at a touch of a button. The ISR function even operates with the unit in other modes.

●ISR memory

1. Select the station that you wish to store in ISR memory.
2. Press and hold **[ISR]** button for 2 seconds or longer.

●Recalling a station with ISR

In any mode, press **[ISR]** button to turn on the radio function and tune the selected radio station. "ISR" appears in the display. Press **[ISR]** button again to return to the previous mode.

CD Operations

Loading a CD

1. Insert a CD into the centre of the insertion slot with the label side facing up. The CD plays automatically after loading.

Notes:

- Never insert foreign objects into the CD insertion slot.
- If the CD is not inserted easily, there may be another CD in the mechanism or the unit may require service.
- Discs not bearing the  mark and CD-ROMs cannot be played by this unit.

Loading 8 cm compact discs

- * No adapter is required to play an 8 cm CD.
- * Insert the 8 cm CD into the centre of the insertion slot.

Listening to a CD already inserted

Press [FUNC] button to select the CD mode. Play starts automatically. If no CD is loaded in the unit, "NO DISC" appears in the display.

Pausing play

1. Press [▶/II] button for 1 second or longer to pause play. "PAUSE" appears in the display.
2. To resume CD play, press [▶/II] button for 1 second or longer again.
 - * The same operation is also available by using the [▶/II] key on the menu screen while in the CD mode.
 - * When the panel is open, the same operation is also available by using the [▶/II] button in the panel.

Ejecting a CD

1. Press the [▲] button a CD ejects. "EJECT" appears in the display.
 - * If a CD (12 cm) is left in the ejected position for 15 seconds, the CD is automatically reloaded. (Auto reload)
 - * 8 cm CDs are not auto reloaded. Be sure to remove it when ejected.

Note:

- If you force a CD into before auto reloading, this can damage the CD.

Selecting a track

●Track-up

1. Press the right (▶▶) side of [SEARCH] button to move ahead to the beginning of the next track.
2. Each time you press the right (▶▶) side of [SEARCH] button, the track advances ahead to the beginning of the next track.
 - * When the panel is open, the same operation is also available by using the [▶▶] button in the panel.

●Track-down

1. Press the left (◀◀) side of [SEARCH] button to move back to the beginning of the current track.
2. Press the left (◀◀) side of [SEARCH] button twice to move to the beginning of the previous track.
 - * When the panel is open, the same operation is also available by using the [◀◀] button in the panel.

Fast-forward/fast-backward

●Fast-forward

Press and hold the right (▶▶) side of [SEARCH] button for 1 second or longer.

- * When the panel is open, the same operation is also available by using the [▶▶] button in the panel.

●Fast-backward

Press and hold the left (◀◀) side of [SEARCH] button for 1 second or longer.

- * When the panel is open, the same operation is also available by using the [◀◀] button in the panel.

Top function

The top function resets the CD player to the first track of the disc. Press [BAND] button to play the first track (track No. 1) on the disc.

Show the menu screen

Touch the screen to show the menu screen while the main screen is being shown.

- * To return to the main screen from the menu screen, touch the [RTN] key.

Scan play

The scan play locates and plays the first 10 seconds of each track on a disc automatically. This function continues on the disc until it is cancelled.

* The scan play is useful when you want to select a desired track.

1. Touch the **[SUB MODE]** key in the MENU display to show SUB MODE.
Touch the **[TRACK SCAN]** key to start scan play. **"TRACK SCAN"** lights in the display.
2. To cancel the scan play, touch the **[TRACK SCAN]** key again. **"TRACK SCAN"** goes off from the display and the current track continues to play.
* The same operation is also available by using the **[SCN]** button in the panel.

Repeat play

The repeat play continuously plays the current track. This function continues automatically until it is cancelled.

1. Touch the **[SUB MODE]** key in the MENU display to show SUB MODE.
Touch the **[TRACK REPEAT]** key. **"TRACK REPEAT"** lights in the display and current track is repeated.
2. To cancel the repeat play, touch the **[TRACK REPEAT]** key again. **"TRACK REPEAT"** goes off from the display and the normal play resumes.
* The same operation is also available by using the **[RPT]** button in the panel.

Random play

The random play selects and plays individual tracks on a disc in no particular order. This function continues automatically until it is cancelled.

1. Touch the **[SUB MODE]** key in the MENU display to show SUB MODE.
Touch the **[TRACK RANDOM]** key. **"TRACK RANDOM"** lights in the display, an individual track is selected randomly and play begins.
2. To cancel the random play, touch the **[TRACK RANDOM]** key again. **"TRACK RANDOM"** goes off and normal play resumes.
* The same operation is also available by using the **[RDM]** button in the panel.

Displaying CD titles

This unit can display title data for CD-text CDs and user titles input with this unit.

Each time you press and hold the **[DISP]** button for 1 second or longer, the title display changes in the following order.

When the panel is closed:

"U-TITLE" (user title) → **"D-TITLE"** (disc title) → **"A-TITLE"** (artist title) → **"T-TITLE"** (track title) → **"U-TITLE"** ...

Note:

- If the CD playing is not a CD-TEXT CD or no user title has been input, **"NO-TITLE"** appears in the display.

When the panel is open:

Each time you touch the **[TITLE INDEX]** key in the MENU display, the title display changes in the following order.

When the **[TEXT]** key is touched, the DISC, TRACK and ARTIST titles are shown. When the **[USER]** key is touched, the user title is shown. Touching the **[INPUT]** key switches the screen to the title input screen.

● Scrolling a CD-text title

Note:

- This function is enabled only when the panel is open.

When a CD-text title is longer than 10 characters, you can scroll the display as follows.

When the panel is open:

1. Display the CD-TEXT TITLE (disk & track & artist).
2. Touch the **[SCROLL]** key to scroll the disc title.
3. To scroll the track title, touch the **[TRACK TITLE]** key. (SCROLL key appears in the right side of the TRACK TITLE.)
Touch the **[SCROLL]** key to scroll the track title.
4. To scroll the artist title, touch the **[ARTIST TITLE]** key. (SCROLL key appears in the right side of the ARTIST TITLE.)

Note:

- If the disc/track/artist title is shorter than 10 characters, the track titles begin to scroll immediately.

VISUAL Operations

This function is available when a VTR, etc. is connected to the visual 1 or visual 2 terminal.

* The visual 1 mode is not available when a DVD changer is connected to the visual 1.

⚠ WARNING

For your safety, the driver should not watch the VTR, etc. or operate the controls while driving. Please note that watching and operating the VTR, etc. while driving are prohibited by law in some countries.

Switching to the VISUAL mode

Note:

• For your safety, the VRX835 has a safety function which turns off the picture when the car is moving, so only the audio can be heard. The picture can only be watched when the car is stopped and the parking break is applied.

1. Press the **[FUNC]** button and select the VISUAL mode.
2. Press the **[BAND]** button to select the VISUAL1 or VISUAL2.

Switching the VTR system between NTSC and PAL

* This function is enabled only when the panel is open.

Switch to the VTR/DVD video/DVD changer mode you use.

1. Press the **[ADJ]** button to switch to the adjustment selection display.
2. Touch the **[▼]** key to select "VTR N/P".
Touch the **[VTR N/P]** key, **[NTSC]** key and **[PAL]** key appears in the display.
3. Touch the **[NTSC]** key or **[PAL]** key to select "NTSC" or "PAL".

Adjusting the brightness and tone of color

Notes:

- This operation is available only when the car is stopped and the parking brake is applied.
- This function is not available when the display is stored.
- The HUE setting can be adjusted only when the NTSC mode is selected.
- Switch to the VTR/TV/DVD video/DVD changer mode you see.

1. Press the **[ADJ]** button to switch to the adjustment selection display.
2. Touch the **[MONI ADJ]** key to display **[BRIGHT]**, **[HUE]** and **[COLOR]** key. Touch the **[BRIGHT]**, **[HUE]** and **[COLOR]** key to adjust BRIGHT, HUE and COLOR.

● "BRIGHT":

Adjust the brightness of the display.

● "HUE":

Adjust the tone of color (red is emphasized or green is emphasized)

● "COLOR":

Adjust the color saturation.

3. Operate the touch key to adjust a level.

● "BRIGHT":

[-] key or **[+]** key

● "HUE":

[R] key or **[G]** key

● "COLOR":

[-] key or **[+]** key

4. When adjustment is made, touch the **[RTN]** key to return to the ADJ MENU display.

Touch the **[RTN]** key again to return to the STANDARD display.

* To return from the adjust a level display to the STANDARD display, press the **[ADJ]** button once again.

Changing over monitor display size

* This function is available only when the panel is open.

Notes:

- This function is not available while you are driving.
- Switch to the VTR/TV/DVD video/DVD changer mode you see.

1. Press the **[DISP]** button to change over the monitor display size. Each time you press the **[DISP]** button, the monitor display size changes in the following order:

"NORMAL" → "WIDE" → "F. WIDE" → "CINEMA" → "NORMAL"

● "NORMAL": (normal display)

There is a black area at both right and left ends of a display. In case of normal TV broadcasting (4:3), the image can be shown without being cut or deformed.

● "WIDE": (wide mode)

The image at right and left ends in a display elongates horizontally.

● "F. WIDE": (full wide mode)

The whole image elongates horizontally.

● "CINEMA": (cinema mode)

The image at both top and bottom in a display disappears.

VISUAL Operations

Notes:

- When a normal 4:3 size image, not being a wide one, is viewed by displaying it fully on a wide monitor display in a wide mode or a full-wide mode, a part of the peripheral image will be lacking or deformed. In deference to the intention of producer, an original image can be viewed in a normal mode.
- During superimposed display, it becomes a full-wide mode.
- In the DVD changer, when the monitor display size is set in the CINEMA mode, a part of playback display such as play time may not be shown depending on the play disc.
In this case, change the monitor display size to a mode other than the CINEMA mode.

Monitoring the CCD camera

The CCD camera can be connected to this unit. For the power supply of the camera, mount the power box sold separately (CAA-188).

Note:

- This function is not available when the display is stored.

Switching to the Composite Screen

- * The composite Screen is the image of device connected to the CCD/M.LOCK terminal.
 - * This function is available when a navigation system, etc. is connected to the CCD/M.LOCK terminal.
 - * This function is not available when a CCD camera is connected to the CCD/M.LOCK terminal.
1. When the panel is open, press the **[M.LOCK]** button to switch to the composite screen. At this time, the sound from the vehicle speakers can be heard on the mode selected using the **[FUNC]** button.
 2. When the panel is open and the composite screen is shown, press the **[M.LOCK]** button again to return to the previous screen.

Switching CONNECT(connect)

- * This function is available when a CCD, etc. is connected to the CCD/M.LOCK terminal.
- * When a navigation system is connected, set this mode to "NAVI".
When an external device other than a navigation system, set this mode to "OTHERS".
- * The factory default setting is "OTHERS".

1. When the panel is open, press the **[ADJ]** button to display the ADJUST MODE menu.
2. Touch the **[▼]** key two times to select "CONNECT".
Touch the **[CONNECT]** key to select "NAVI" or "OTHERS".
3. Press the **[ADJ]** button again or touch the **[RTN]** key, the unit returns to the previous mode.

CD/MD Changer Operations

CD/MD changer functions

When an optional CD (MD) changer is connected through the CeNET cable, this unit controls all CD (MD) changer functions. This unit can control a total of 2 changers (MD and/or CD).

Press the **[FUNC]** button and select the CD changer mode to start play. If 2 CD (MD) changers are connected, press the **[FUNC]** button to select the CD (MD) changer for play.

- * If "NO MAG" appears in the display, insert the magazine into the CD changer. "LOADING" appears in the display while the player loads (checks) the magazine.
- * If "NO DISC" appears in the display, eject the magazine and insert discs into each slot. Then, reinsert the magazine back into the CD changer.
- * If "NO DISC" appears in the display, load MDs into the MD changer.

⚠ CAUTION

CD-ROM discs cannot be played in the CD changer.

Pausing play

1. Press the **[▶/||]** button for 1 second or longer to pause play. "PAUSE" appears in the display.
2. To resume play, press the **[▶/||]** button for 1 second or longer again.
 - * The same operation is also available using the **[▶/||]** key in the menu screen while in the CD/MD changer mode.
 - * When the panel is open, the same operation is also available by using the **[▶/||]** button in the panel.

Displaying CD titles (CD)

This operation is only possible when this unit is connected with a CD-text compatible CD changer. When a title is longer than 10 characters, the same operation can be performed on a CD.

CD/MD Changer Operations

Switching disc titles and track titles (MD)

This unit can display disc titles and track titles already entered on MDs. Titles up to 256 characters long can be displayed by scrolling the titles.

* Titles cannot be entered for MDs with this unit.

When the panel is closed:

1. Press the [DISP] button to show the SUB display. The disc title or track title is displayed.
2. Each time you press and hold the [DISP] button for 1 second or longer, the display toggles between the disc title and the track title.

When the panel is open:

1. Touch the screen to show the menu screen while the main screen is being shown.
2. Touch the [TITLE INDEX] key to show the title display screen.
3. Touch the disc title/track title display you want to show in the main screen.

Scrolling titles (MD)

Note:

- This function is enabled only when the panel is open.

When a title is longer than 10 characters, the same operation can be performed on a CD.

Notes:

- When the disc title is within 10 characters, the title is scrolled immediately.
- If the track title is shorter than 10 characters, the track titles does not scroll.

Selecting an MD

When the panel is closed:

Each of the [DIRECT] button corresponds to an MD loaded into the MD changer.

Press the [DIRECT] button (1 to 6) and select the desired MD.

When the panel is open:

Each of the [DIRECT] key corresponds to an MD loaded into the MD changer.

Touch the [DISC SELECT] key in the display, the [DIRECT] key (1 to 6) appears in the display.

Touch the [DIRECT] key (1 to 6) and select the desired MD.

Selecting a CD

When the panel is closed:

Each of the [DIRECT] buttons corresponds to a disc loaded into the magazine.

●Selecting a disc from 1 to 6

Press the corresponding [DIRECT] button (1 to 6) to select the desired disc.

●Selecting a disc from 7 to 12 (only when a 12 disc CD changer is used.)

Press the corresponding [DIRECT] button (1 to 6) for 1 second or more, then select the desired disc.

When the panel is open:

Each of the [DIRECT] keys corresponds to a disc loaded into the magazine.

●Selecting a disc from 1 to 6

Touch the [DISC SELECT] key in the display, the [DIRECT] key (1 to 6) appears in the display. Touch the corresponding [DIRECT] key (1 to 6) to select the desired disc.

●Selecting a disc from 7 to 12 (Only when a 12 disc CD changer is used.)

Touch the [DISC SELECT] key again, the [DIRECT] key (7 to 12) appears in the display.

Touch the corresponding [DIRECT] key (7 to 12) to select the desired disc.

Selecting a track

●Track-up

1. Press the right side (▶▶) of the [SEARCH] button to move ahead to the beginning of the next track.
2. Each time you press the right side (▶▶) of the [SEARCH] button, the track advances ahead to the beginning of the next track.

* When the panel is open, the same operation is also available by using the [▶▶] button in the panel.

●Track-down

1. Press the left (◀◀) side of the [SEARCH] button to move back to the beginning of the current track.
2. Press the left side (◀◀) of the [SEARCH] button twice to move to the beginning of the previous track.

* When the panel is open, the same operation is also available by using the [◀◀] button in the panel.

Fast-forward/Fast-backward

● Fast-forward

Press and hold the right side (▶▶) of the [SEARCH] button for 1 second or longer.

- * When the panel is open, the same operation is also available by using the [▶▶] button in the panel.

● Fast-backward

Press and hold the left side (◀◀) of the [SEARCH] button for 1 second or longer.

- * When the panel is open, the same operation is also available by using the [◀◀] button in the panel.

Top function (CD)

The top function plays from the first track (track No. 1) of the disc.

● When playing a disc 1 to 6

Press the [DIRECT] button (1 to 6) with the same number as the CD playing.

● When playing a disc 7 to 12 (only when a 12 disc CD changer is used.)

Press the [DIRECT] button (1 to 6) with the same number as the CD playing for 1 second or longer.

Top function (MD)

The top function plays from the first track (track No. 1) of the disc.

Press the [DIRECT] button (1 to 6) with the same number that the MD playing.

- * If an MD is not loaded in a slot of the MD changer, pressing the [DIRECT] button corresponding to its disc number is invalid.

Scan play

The scan play locates and plays the first 10 seconds of each track on a disc automatically. This function continues on the disc until it is cancelled or the mode is changed.

- * The scan play is useful when you want to select a desired track.

1. Touch the [SUB MODE] key in the MENU display to show SUB MODE.
Touch the [TRACK SCAN] key to start scan play.
2. Touch the [TRACK SCAN] key again to cancel the scan play. Current track continues to play.

- * The same operation is also available by using the [SCN] button in the panel.

Disc scan play

The disc scan play locates and plays the first 10 seconds of the first track on each disc in the currently selected CD (MD) changer. This function continues automatically until it is cancelled or the mode is changed.

- * The disc scan play is useful when you want to select a desired CD (MD).

1. Touch the [SUB MODE] key in the MENU display to show SUB MODE.
Touch the [DISC SCAN] key to start disc scan play.
2. Touch the [DISC SCAN] key again to cancel disc scan play. Normal disc play continues on the current track.
 - * The same operation is also available by using the [SCN] button for 1 second or longer in the panel.

Repeat play

The repeat play continuously plays the current track. This function continues automatically until it is cancelled.

1. Touch the [SUB MODE] key in the MENU display to show SUB MODE.
Touch the [TRACK REPEAT] key, to make repeat play starts. "TRACK REPEAT" lights in the display.
2. To cancel repeat play, touch the [TRACK REPEAT] key. "TRACK REPEAT" goes off from the display and the unit returns to normal play.
 - * The same operation is also available by using the [RPT] button in the panel.

Disc repeat play

After all tracks in the current disc have been played, the disc repeat play automatically replays the current disc over from the first track. This function continues automatically until it is cancelled.

1. Touch the [SUB MODE] key in the MENU display to show SUB MODE.
Touch the [DISC REPEAT] key, disc repeat play starts, "DISC REPEAT" light in the display.
2. To cancel disc repeat play, touch the [DISC REPEAT] key again. "DISC REPEAT" goes off from the display and the unit returns to normal play from the track being played.
 - * The same operation is also available by using the [RPT] button for 1 second or longer in the panel.

CD/MD Changer Operations

Random play

The random play selects and plays individual tracks on the disc in no particular order. This function continues automatically until it is cancelled.

1. Touch the **[SUB MODE]** key in the MENU display to show SUB MODE.
When you touch the **[TRACK RANDOM]** key, random play starts. "TRACK RANDOM" lights in the display.
2. To cancel random play, touch the **[TRACK RANDOM]** key again. "TRACK RANDOM" goes off from the display and the unit returns to normal play.
 - * The same operation is also available by using the **[RDM]** button in the panel.

Disc random play

The disc random play selects and plays individual tracks or discs automatically in no particular order. This function continues automatically until it is cancelled.

1. Touch the **[SUB MODE]** key in the MENU display to show SUB MODE.
When you touch the **[DISC RANDOM]** key, disc random play starts. "DISC RANDOM" lights in the display.
2. To cancel disc random play, touch the **[DISC RANDOM]** key again. "DISC RANDOM" goes off from the display and the unit returns to normal play from the track being played.
 - * The same operation is also available by using the **[RDM]** button for 1 second or longer in the panel.

DVD Changer Operation

DVD changer functions

When an optional DVD changer is connected through the CeNET cable.

In this case, this unit only provides a part of the DVD changer functions. As for other operations not written in this manual, operates with a remote control unit provided with your DVD changer. Refer to the DVD changer owners' manual for details.

This unit can control a total of 2 changers (CD or MD or DVD).

Press the **[FUNC]** button and select the DVD changer mode to start play.

- * If "NO MAGAZINE" appears in the display, insert the magazine into the DVD changer.
- * "DISC CHECKING" appears in the display while the player loads (checks) the magazine.
- * If "NO DISC" appears in the display, eject the magazine and insert discs into each slot. Then, reinsert the magazine back into the DVD changer.

Pausing Play

1. Press and hold the **[▶/||]** button for 1 second or longer to pause play. "PAUSE" appears in the display.
2. To resume play, press the **[▶/||]** button for 1 second or longer again.
 - * When the panel is open, the same operation is also available by using the **[▶/||]** button in the panel.

Slow Play (DVD video & video CD)

1. Press and hold the **[▶/||]** button for 1 second or longer then press and hold the **[▶▶]** button. While the button is being pressed, slow playback continues at the speed 1/2 times the normal playback.
 - * Slow playback cannot be performed in the backward direction. In addition, audio cannot be reproduced during slow playback.

Selecting a disc

1. Each of the **[DIRECT]** buttons corresponds to a disc loaded into the magazine.
2. Press the corresponding **[DIRECT]** buttons (1 to 6) to select the desired disc.

Switching to a next disc(Disc Up function)

The disc up function plays from the first track (track No1) of the next disc.

DVD Changer Operation

1. Press the [BAND] button.
2. Each time you press the [BAND] button, the disc changes to the next disc.

DVD-Video Operation

Skipping a chapter (searching)

About chapter

Chapter means a small segment to divide the data area of the disc.

1. Press the [◀] or [▶] button during playback.
Chapters are skipped, as many as the times the button is pressed, and playback starts.
 - Press the [▶] button, and playback starts from the beginning of the next chapter.
 - Press the [◀] button, and playback starts from the beginning of the current chapter.
When this button is pressed again within about 2 seconds, playback starts from the beginning of the previous chapter.
 - The unit may return to the menu screen when the [◀] or [▶] button is pressed.

Fast forward and fast backward

1. Press and hold the [◀] or [▶] button during playback.

Press and hold the button, and the playback speed becomes 4-time faster first and then 16-time faster 3 seconds later. Release the button, and the normal speed is restored.

Notes:

- No audio is reproduced during fast forward and fast rewind operation.
- The fast forward and fast rewind speed may differ depending on the disc.
- The menu screen may appear when the button is pressed.

Scan playback

Scans and plays back all chapters recorded on the DVD-Video, the first 10 seconds for each.

1. Press the [SCN] button.
2. Press the [SCN] button again and scan playback is turned off.

Chapter repeat playback

This operation plays back chapters recorded on the DVD-Video repeatedly.

1. Press the [RPT] button.

2. Press the [RPT] button again and repeat playback is turned off.

Title repeat playback

This operation plays back titles recorded on the DVD-Video repeatedly.

1. Press and hold the [RPT] button for 1 second or longer.
2. Press the [RPT] button again and repeat playback is turned off.

Watching a video CD

Skipping a track (searching)

1. Press the [◀] or [▶] button during playback.

The track is skipped, and playback starts.

- Press the [▶] button, and playback starts from the beginning of the next track.
- Press the [◀] button, and playback starts from the beginning of the current track.
When this button is pressed again within about 2 seconds, playback starts from the beginning of the previous track.

* This operation cannot be performed on some discs with PBC

Fast forward and fast backward

1. Press and hold the [◀] button or [▶] button during playback.

Press and hold the button, and the playback speed becomes 4-time faster first and then 16-time faster 3 seconds later. Release the button, and the normal speed is restored.

Notes:

- No audio is reproduced during fast forward and fast rewind operation.
- The unit may return to the menu screen when the button is pressed.

Scan playback

This operation plays back all tracks on the disc, the first 10 seconds for each.

1. Press the [SCN] button.
2. Press the [SCN] button again and scan playback is turned off.

* If you are playing a disc with PBC and the PBC function is engaged, this operation cannot be performed.

DVD Changer Operation

Repeat playback

This operation plays back one track recorded on the video CD repeatedly.

1. Press the [RPT] button.
2. Press the [RPT] button again and repeat playback is turned off.
 - * If you are playing a disc with PBC and the PBC function is engaged, this operation cannot be performed.

Random playback

This operation plays back all track on the disc in no particular order.

1. Press the [RDM] button.
2. Press the [RDM] button again and random playback is turned off.
 - * If you are playing a disc with PBC and the PBC function is engaged, this operation cannot be performed.

Listening to a CD

Skipping a track (searching)

1. Press the [◀] or [▶] button during playback.

The tracks are skipped, as many as the times the button is pressed, and playback starts.

 - Press the [▶] button, and playback starts from the beginning of the next track.
 - Press the [◀] button, and playback starts from the beginning of the current track.

When this button is pressed again within about 2 seconds, playback starts from the beginning of the previous track.

Fast forward and fast backward

1. Press and hold the [◀] or [▶] button during playback.

Press and hold the button, and the playback speed becomes 4-time faster first and then 8-time faster 3 seconds later. Release the button, and the normal speed is restored.

Scan playback

This operation plays back all tracks on the disc, the first 10 seconds for each.

1. Press the [SCN] button.
2. Press the [SCN] button again and scan playback is turned off.

Track repeat playback

This operation plays back one track recorded on the CD repeatedly.

1. Press the [RPT] button.
2. Press the [RPT] button again and repeat playback is turned off.

Disc repeat playback

This operation plays back all tracks on the disc repeatedly (with music CDs only).

1. Press and hold the [RPT] button for 1 second or longer.
2. Press the [RPT] button again and repeat playback is turned off.

Random playback

This operation plays back all track on the disc in no particular order.

1. Press the [RDM] button.
2. Press the [RDM] button again and random playback is turned off.

Listening to an MP3

Skipping a track (searching)

1. Press the [◀] or [▶] button during playback.

The tracks are skipped, as many as the times the button is pressed, and playback starts.

 - Press the [▶] button, and playback starts from the beginning of the next track.
 - Press the [◀] button, and playback starts from the beginning of the current track.

When this button is pressed again within about 2 seconds, playback starts from the beginning of the previous track.

 - * This operation skips the track over the folder.

Fast forward and fast backward

1. Press and hold the [◀] or [▶] button during playback.

Press and hold the button, and the playback speed becomes 4-time faster first and then 8-time faster 3 seconds later. Release the button, and the normal speed is restored.

DVD Changer Operation

Track scan playback

This operation plays back all files recorded on the disc, about 10 seconds for each.

1. Press the [SCN] button.
2. Press the [SCN] button again and scan playback is turned off.

Folder scan playback

This operation plays back the first files of all folders on the MP3 disc, about 10 seconds for each.

1. Press and hold the [SCN] button for 1 second or longer.
2. Press the [SCN] button again and scan playback is turned off.

Track repeat playback

This operation plays back the file currently being played back repeatedly.

1. Press the [RPT] button.
2. Press the [RPT] button again and repeat playback is turned off.

Folder repeat playback

This operation plays back files in an MP3 folder repeatedly..

1. Press and hold the [RPT] button for 1 second or longer.
2. Press the [RPT] button again and repeat playback is turned off.

Track random playback

This operation plays the file in the folder in random order.

1. Press the [RDM] button.
2. Press the [RDM] button again and random playback is turned off.

Folder random playback

This operation plays back tracks recorded on the disc in no particular order.

1. Press and hold the [RDM] button for 1 second or longer.
2. Press the [RDM] button again and random playback is turned off.

TV Operations

TV functions

When an optional TV tuner is connected through the CeNET cable, this unit controls all TV tuner functions. To watch TV requires a TV tuner.

WARNING

For your safety, the driver should not watch the TV or operate the controls while driving. Please note that watching and operating the TV while driving are prohibited by law in some countries.

Watching TV

Note:

• For your safety, the VRX835 has a safety function which turns off the picture when the car is moving, so only the audio can be heard. The picture can only be watched when the car is stopped and the parking break is applied.

1. Press the [FUNC] button and select the TV mode.
2. Press the [BAND] button to select the desired TV band (TV1 or TV2). Each time the button is pressed, the input selection toggles between TV1 and TV2.
3. Press the right (▶▶) or left (◀◀) side of the [SEARCH] button to tune in the desired TV station.

Watching a video

The TV tuner has a VTR input terminal to which 1 external device can be connected. Connect a 12V video cassette player (VCP) or video cassette recorder (VCR) to the TV tuner input terminal.

1. In the TV mode, touch the [EXTRA SELECT] key in the MENU display to select the [VTR] key.
2. To return to the TV broadcast, touch the [EXTRA SELECT] key in the MENU display to select the [TELEVISION] key.

Tuning

There are 3 types of tuning mode available, seek tuning, manual tuning and preset tuning.

TV Operations

Seek tuning

1. Press the **[BAND]** button and select the desired TV band (TV1 or TV2).
 - * If "**MANU**" is lit in the display (or when the panel is closed, if the indicator "**SRCH**" is not lit), press and hold the **[BAND]** button for 1 second or longer. "**MANU**" in the display goes off (or when the panel is closed, the indicator "**SRCH**" lights) and seek tuning is now available.
2. Press the right (▶▶) or left (◀◀) side of the **[SEARCH]** button to automatically seek a station. Press the right (▶▶) side of the **[SEARCH]** button to automatically tune up the frequency band to the next available TV station; press the left side to automatically tune down.

Manual tuning

There are 2 ways available: Quick tuning and step tuning. When you are in the step tuning mode, the frequency changes one step at a time. In quick tuning mode, you can quickly tune the desired frequency.

1. Press the **[BAND]** button and select the desired band. (TV1 or TV2)
 - * If "**MANU**" is not lit in the display (or when the panel is closed, if the indicator "**SRCH**" is lit), press and hold the **[BAND]** button for 1 second or longer. "**MANU**" appears in the display (or when the panel is closed, the indicator "**SRCH**" goes off) and manual tuning is now available.
2. Tune into a station.

● Quick tuning:

Press and hold the right (▶▶) or left (◀◀) side of the **[SEARCH]** button for 1 second or longer to tune in a station.

● Step tuning:

Press the right (▶▶) or left (◀◀) side of the **[SEARCH]** button to manually tune in a station.

Note:

- Manual tuning is cancelled if you do not operate the unit for 7 seconds longer. (*Only when connecting the TTX7503Z or TTX7504Z with this unit)

Recalling a preset station

A total of 12 TV stations can be stored (6-TV1 and 6-TV2). This allows you to select your favorite TV stations and store them in memory for later recall.

1. Press the **[BAND]** button and select the desired TV band. (TV1 or TV2)
2. To recall a stored TV station, press the desired **[DIRECT]** button to select that station.
 - * Press and hold one of the **[DIRECT]** buttons for 2 seconds or longer to store the current station into the preset memory.
 - * When the panel is open, the same operation is also available by using the [◀◀] and [▶▶] button in the panel.

Manual memory

1. Select the desired station with seek tuning, manual tuning or preset tuning.
2. Press and hold one of the **[DIRECT]** buttons for 2 seconds or longer to store the current station to that preset memory.

Auto store

Auto store selects 6 TV stations automatically and stores each one into a preset memory.

If there are not 6 stations with good reception, stations previously stored in memory remain and only the strong stations are stored into memory.

1. Press the **[BAND]** button and select the desired TV band. (TV1 or TV2)
2. Touch the **[SUB MODE]** key in the MENU display, the **[AUTO STORE]** key appears in the display.

Touch and hold the **[AUTO STORE]** key for 2 seconds or longer. The stations with good reception are stored automatically to the preset channels.

- * The same operation is also available by using the **[SCN]** button for 2 seconds or longer in the panel.

Preset scan

Preset scan allows the user to view each preset position before it automatically advances to the next preset. This function is useful for searching for desired TV station in memory.

TV Operations

1. Touch the **[SUB MODE]** key in the MENU display, the **[PRESET SCAN]** key appears in the display.
Touch the **[PRESET SCAN]** key to start pre-set scan.
2. When the desired channel is received, touch the **[PRESET SCAN]** key again.
* The same operation is also available by using the **[SCN]** button in the panel.

Setting the TV diver

- * This function is enabled only when the panel is open.
- * Normally use the TV diver with the "ON" position.

You can change the reception setting for the TV antenna connected to the TV tuner.

1. Press the **[ADJ]** button to switch to the adjustment selection display.
2. Touch the **[▼]** key to select "TV DIVER".
Touch the **[TV DIVER]** key to display **[ON]/[OFF]** key.
3. Touch the **[ON]** key or **[OFF]** key to set the selected reception setting.
 - **ON:**
Sets reception emphasizing the visual.
 - **OFF:**
Sets the diver setting to OFF.
4. Press the **[ADJ]** button to return to the previous mode.

Setting the TV area

- * This function is enabled only when the panel is open.

When you select the TV area (TV reception area), the TV tuner area setting changes.

1. Press the **[ADJ]** button to switch to the adjustment selection display.
2. Touch the **[▼]** key to select "TV AREA".
Touch the **[TV AREA]** key to display a list of country name.
3. Touch the **[COUNTRY NAME]** key to select a desired country.
4. When the setting is finished, touch the **[RTN]** key in the TV AREA selection display to return to the STANDARD display.
* To return from the TV AREA select display to the STANDARD display, press the **[ADJ]** button once again.

Other Functions

Always turning on the button illumination on the operation panel

Notes:

- The following operation is enabled when the panel is open.
- Doing this operation turns on and off the illumination only for the buttons of VoL [+], and [-], [TILT], and [OPEN].

The button illumination on the operation panel when the display is turned upward, can be switched between "ON" and "OFF".

- "OFF": Button illumination on the operation panel turns on for 5 seconds;
- "ON": Button illumination is always on when the power is turned on;

1. When the panel is open, press the **[ADJ]** button to show the adjustment selection display.
2. Touch the **[UPPER ILLUMI]** key to select "ON" or "OFF".
3. Touch the **[ON]** or **[OFF]** key for setting.
4. Press the **[ADJ]** button to return to the previous mode.
* To set "ON" again, switch "OFF" to "ON" manually.

Entering titles

Titles up to 10 characters long can be stored in memory and displayed for Radio stations, TV stations and CDs. The numbers of titles that can be entered for each mode are as follows.

Mode	Number of titles
TUNER mode	30 titles
TV mode	15 titles
CD mode	50 titles

CD changer mode	Number of titles
CDC655z connected	60 titles
CDZ625, CDC655Tz connected	100 titles
CDC1255z connected	50 titles

- * You cannot enter titles with the unit in Seek, Pre-set Scan, Auto store (TUNER, TV) mode. Cancel each of those operations before entering titles.

1. Press the **[FUNC]** button to select the mode you want to enter a title (TUNER, CD, CD changer or TV).
2. Select and play a CD or a CD in the CD changer or tune in to a Radio station or a TV station for which you want to enter the title.

Other Functions

- Touch the [TITLE INPUT] key in the MENU display.
Touch the [INPUT] key in the USER TITLE display, the display switches to the title input mode display.
 - Touch the characters, symbols, etc. shown in the display to input titles.
“←, →” : Centering
“BS” : Backspace
“□” : Space
“MEMO” : Memory
“▼(▲)” : Scroll
- Note:**
- Up to 10 characters can be input.
 - To switch the character types, touch the scroll key (▼) at the lower left of the display.
- Repeat the step 4 to enter the complete title.
 - Touch the [MEMO] key for 2 seconds or longer to store the title into memory and cancel title input mode.

Title list play

You can display a list of titles, then select the disc or broadcast station to listen to from that list.

- * You can not display a title list with the unit in Seek, Preset Scan, Auto store (Tuner, TV) mode. Cancel those operation modes before to display a title list.
- With the unit in radio, CD/MD changer, TV mode, touch the [P. CH SELECT], [DISC SELECT] key. A title list is displayed. The following functions can be carried out in a title list display.
 - **TUNER:** A title of a station stored in the presets 1 to 6 or frequency is displayed;
 - **CD/MD changer:** DISC titles for discs 1 to 6 are displayed (By changing over a display page in case of 12-CD changer, disc 7 to 12 can be displayed). When there is not any disc in a changer, “NO DISC” is displayed.
 - **TV:** A title of a channel stored in the presets 1 to 6 or a channel number is displayed.
 - Touch the [DIRECT] key (1 to 6) to select one of the items 1 to 6 and reproduce the selected broadcast station or disc.
 - * In case of 12-CD changer, touch the [DISC SELECT] key to change over to a list display of discs 7 to 12.
 - Touch the [RTN] key again to return to the STANDARD display.

Adjusting the dimmer level

You can adjust the reduced illumination level of the dimmer. When driving at night with the inside of the car, the auto dimmer function can reduce the display illumination linked “to the illumination power supply of the car” in this unit in order to prevent glare from the display.

● The factory default:

When the car light is off: Brightest setting

When the car light is on: Medium brightness

- When the panel is open, press the [ADJ] button to display the adjustment selection display.
- Touch the [DIMMER LEVEL] key to adjust the dimmer level.
- Touch the [+] or [-] key to adjust.
- Press the [ADJ] button again or touch the [RTN] key two times.
The unit returns to the previous mode.

Setting the button illumination

* The factory default setting is “GREEN” (green).

- When the panel is open, press the [ADJ] button to select the adjustment mode.
- Touch the [KEY ILLUMI] key to select “RED” (red) or “GREEN” (green).
- Touch the [RED] or [GREEN] key to select a desired mode and set it.
- Press the [ADJ] button again or touch the [RTN] key. The unit returns to the previous mode.

Setting the beep

* The sound heard when you make operations is called “beep”. The unit can be set up so that it does not produce this beep sound.

* The factory default is “BEEP ON”.

- When the panel is open, press the [ADJ] button to select the adjustment mode.
- Touch the [▼] key two times to select “BEEP”.
Touch the [BEEP] key to select “ON” and “OFF”.
- Touch the [ON] or [OFF] key to select a desired mode and set it.
- Press the [ADJ] button again or touch the [RTN] key, The unit returns to the previous mode.

Other Functions

Setting the sprite pattern speed

* The factory default setting is "MID" (mid).

1. When the panel is open, press the [ADJ] button to select the adjustment mode.
2. Touch the [ANA SENS] key to select "HIGH" (high) or "MID" (mid) or "LOW" (low).
3. Touch the "HIGH" (high) or "MID" (mid) or "LOW" (low) key to select a desired mode and set it.
4. Press the [ADJ] button again or touch the [RTN] key. The unit returns to the previous mode.

Clock Adjustment

1. When the panel is open, press the [ADJ] button to select the adjustment mode.
2. Touch the [▼] key to select "CLOCK".
Touch the [CLOCK] key to adjust the time.
3. Touch the [▲],[▼],[a.m] or [p.m] key to adjust the time.
* The time is displayed in 12-hour format.
4. Press the [ADJ] button again or touch the [RTN] key two times. The unit returns to the previous mode.

Triggered audio mute for cellular telephones

This unit requires special wiring to mute the audio signal automatically when a cellular telephone rings in the car.

* This function is not compatible with all cellular telephones. Contact your local authorized Clarion dealer for information on proper installation and compatibility.

DSP operations

DSP control function

If the DSP (DPH910), sold separately, is connected to this unit using the CeNET cable, all the functions of the DSP can be controlled.

* DSP control can all be operated only when the panel is open.

DSP functions

There are 2 modes available in DPH910, standard mode and professional mode. Choose one of them and adjust the sound field and the sound quality.

● Functions common to each mode:

Such as auto loudness, subwoofer etc.

● Standard mode:

Adjustment using the graphic equalizer function and the DSF (Digital Sound Field) function.

● Professional mode:

Adjustment using the VSE (Virtual Space Enhancer) function and the parametric equalizer function.

* When the standard mode is selected, adjustment for the professional mode cannot be made. On the contrary, when the professional mode is selected, adjustment for the standard mode cannot be made.

* For details on functions of each mode, refer to the owner's manual supplied with the DPH910.

* Hereafter the graphic equalizer is referred to as a G.EQ, referred to as VSE and the parametric equalizer referred to as P.EQ.

Operations common to each mode

Output adjustment of auto loudness, subwoofer and playback band

1. Press the [ADJ] button to switch to the adjustment selection display.

2. Touch the [▼] key two times to select "SOUND".

Touch the [SOUND] key to change into the Sound adjustment display.

In the Sound adjustment display "AUTO LOUD", "W-OUT", "W-LFP", "HPF", "TEST-T" are listed.

Touch the [LIST] key to select an item to be adjusted.

3. To make an adjustment on:

● Auto loudness adjustment

Touch the [▲] or [▼] key to adjust an auto loudness level (0 to 10).

DSP operations

● Woofer out adjustment

Select woofer output out of "STEREO", "MONO", or "OFF".

Touch the select a desire item key to set it.

● Woofer LPF adjustment

Select woofer LPF slope out of "50Hz", "80Hz", "120Hz".

Touch the select a desire item key to set it.

● HPF adjustment

Select HPF slope out of "50Hz", "80Hz", "120Hz", or "OFF".

Touch the select a desire item key to set it.

● Test Tone Output

Select Test Tone Output

Touch the select a desire item key to produce a test tone.

- After adjustment (setting), touch the [RTN] key to return to the adjustment selection display.
- Press the [ADJ] button again or touch the [RTN] key to return to the STANDARD display.

Selecting the Standard mode or the professional mode

* The factory default setting is "STANDARD".

- Press the [ADJ] button to switch to the adjustment selection display.
- Touch the [▼] key two times to select "AC PROCESSOR".
Touch the [AC PROCESSOR] key to select "PRO" and "STANDARD".
- Touch the [PRO] or [STANDARD] to select a desired mode and to set the mode thus selected.
- After setting, press the [ADJ] button again to return to the STANDARD display.

Woofer level adjustment

You can adjust an output sound level of subwoofer.

- Press the [A-M] button to show the AUDIO-MODE display.
- Touch the [WOOFER VOL] key to show the woofer level adjusting display.
- Touch the [▲] or [▼] key to adjust the level (0 to 14)
- After adjustment, touch the [RTN] key to return to the STANDARD display.

Entering titles

You can give a title to the user memory of the G.EQ, DSF, VSE and P.EQ that you have adjusted yourself.

- Press the [A-M] button to select the adjustment mode in which you want to give a title.
- Touch the [USER] key to select the "USER".
- Touch the [USER TITLE] key to select the user memory to which you want to give a title.
- Touch the [TITLE] key in the USER TITLE display, the display switches to the title input mode display.
- Touch the characters, symbols, etc. shown in the display to enter titles.
"←, →" : Centering
"BS" : Backspace
"□" : Space
"MEMO" : Memory
"▼(▲)" : Scroll

Note:

- Up to 8 characters can be input.
 - To switch the character types, touch the scroll key (▲) at the lower left of the display.
- Repeat the step 5 to input the title.
 - Touch the [MEMO] key for 2 seconds or longer to store the title into memory.
 - Press the [A-M] button again. The unit returns to the previous mode.

Standard mode/Setting the listening position

Selection of listening position

- Press the [A-M] button to show the AUDIO-MODE display.
- Touch the [▼] key to select "POSI. SELECT".
Touch the [POSI. SELECT] key to set the listening position type.

There are FULL SEAT, FRONT R (only right seat), FRONT L (only left seat), FRONT (only front seats), REAR (only rear seats) and PASS available for the listening position types.

* The factory default setting is "FULL SEAT".

Detail adjustment of listening position

- Press the [A-M] button to show the AUDIO-MODE display.

DSP operations

- Touch the [▼] key to select "POSI. DETAIL".
Touch the [POSI. DETAIL] key to show Position Detail adjusting display.
 - Touch the [▲] or [▼] key to adjust to a desired fader.
Adjusting range of the fader: front 9/rear 9
 - Touch the [▶] or [◀] key to adjust to a desired balance.
Adjusting range of the balance: left 9/right 9
 - When the adjustment is finished, press the [A-M] button again or touch the [RTN] key two times to return to the STANDARD display.
- * After selecting the G.EQ pattern, touch the [MEMO] key to copy the selected pattern to the USER pattern.
 - * Touch the [EDIT] key to show G.EQ adjusting display, in which the properties of currently selected pattern can be adjusted.
 - * By pressing the [BAND] button in BASIC pattern selecting display or USER pattern selection/memory display you can switch between the two patterns, BASIC and USER.
- After the selecting, press the [A-M] button again or touch the [RTN] key two times to return to the STANDARD display.

Standard mode/G.EQ operations

Note:

- The adjustment made in standard mode is not reflected in the adjustment in professional mode. Respectively, the adjustment made in professional mode is not reflected in the adjustment in standard mode.

G.EQ effect ON/OFF

- * The factory default setting is "ON".

- Press the [A-M] button to show the AUDIO-MODE display.
- Touch the [G.EQ ON/OFF] key to select "on" and "off".
- Each time the [ON/OFF] key is touched, the on and off statuses are switched alternately.
- After the setting, press the [A-M] button again or touch the [RTN] key to return to the STANDARD display.

Note:

- If the G.EQ effect is set to OFF, the adjustment made in "G.EQ operations" is not reflected in the music source.

Calling G.EQ BASIC Pattern/USER Pattern

- Press the [A-M] button to show the AUDIO-MODE display.
- Touch the [G.EQ BASIC] and [G.EQ USER] key to show BASIC pattern selecting display or USER pattern selection/memory display.
- In the pattern selecting display, touch the one of pattern key and called the desired G.EQ pattern.

In this display, pressing the No. button in correspondence to the [DIRECT] key can also call the G.EQ pattern.

Setting and storing G.EQ Properties/Memory into USER Pattern

- Repeat the steps 1 and 2 of the previous procedure (Calling G.EQ BASIC pattern/USER pattern) to show BASIC pattern selecting display or USER pattern selection/memory display.
- Touch the [EDIT] key to show the G.EQ adjusting display.
- When some frequency to be adjusted is selected by touching the [▶] key or [◀] key (or the frequency key) in the G.EQ adjusting display, a gain setting value at the selected frequency is displayed.
There are "50Hz", "100Hz", "200Hz", "400Hz", "1kHz", "3kHz" and "12kHz" available for the adjustment frequency.
- Touch the [▲] or [▼] key to adjust the G.EQ GAIN. The adjustment range is from -12 dB to +12 dB.
- After making adjustments to a desired pattern by repeating the operations of items 3 and 4, touch the [RTN] key to change over to the BASIC/USER pattern selection/memory display.
- Press and hold one of [DIRECT] buttons for 2 seconds or longer to store the adjusted G.EQ pattern to be USER memory.
- To set a title of the stored USER pattern, touch the [TITLE] key to change into the [TITLE INPUT] key.
* For title inputting method, refer to the section "Entering titles".
- Press the [A-M] button to change into the STANDARD display.

DSP operations

Standard mode/DSF operations

DSF effect ON/OFF

* The factory default setting is “ON”.

1. Press the **[A-M]** button to show the AUDIO-MODE display.
2. Touch the **[DSF ON/OFF]** key to select “on” and “off”.
3. Each time the **[ON/OFF]** key is touched, the on and off statuses are switched alternately.
4. After the setting, press the **[A-M]** button again or touch the **[RTN]** key to return to the STANDARD display.

Note:

- If the DSF effect is set to OFF, the adjustment made in “**DSF operations**” is not reflected in the music source.

Calling DSF BASIC Pattern/USER Pattern

1. Press the **[A-M]** button to show the AUDIO-MODE display.
2. Touch the **[▼]** key to select DSF mode. Touch the **[DSF BASIC1]**, **[DSF BASIC2]** and **[DSF USER]** key to show BASIC pattern selecting display or USER pattern selection/memory display.
3. In the pattern selecting display, touch the one of pattern key to call corresponding DSF mode.

In this display, pressing the No. button in correspondence to the **[DIRECT]** key can also call the DSF mode.

- * After selecting the DSF mode, touch the **[MEMO]** key to copy the selected pattern to the USER pattern.
 - * Touch the **[EDIT]** key to show DSF adjusting display, in which the properties of currently selected pattern can be adjusted.
 - * By pressing the **[BAND]** button in BASIC pattern selecting display or USER pattern selection/memory display you can switch between the two patterns, BASIC and USER.
4. After the setting, press the **[A-M]** button again or touch the **[RTN]** key two times to return to the STANDARD display.

Setting and storing DSF Properties/Memory into USER Pattern

1. Repeat the steps 1 and 2 of the previous procedure (Calling DSF BASIC Pattern/USER Pattern) to show BASIC pattern selecting display or USER pattern selection/memory display.
2. Touch the **[EDIT]** key to show the DSF adjusting display.
3. Select an item to be adjusted by touching **[ITEM]** key in the DSF adjusting display.
There are “**EFFECT**”, “**DELAY**”, “**REAR MIX**”, “**REVERB TIME**” (ROOM SIZE) and “**HIGH**” (LIVENESS).
4. Touch the **[▲]** or **[▼]** key to set each adjusting value.
5. After making adjustments to a desired pattern by repeating the operations of items 3 and 4, touch the **[RTN]** key to change over to the BASIC/USER patterns selection/memory display.
6. Press and hold one of **[DIRECT]** button for 2 seconds or longer to store the adjusted DSF pattern to the USER memory.
7. To set a title of the stored USER pattern, touch the **[TITLE]** key to change into the **[TITLE INPUT]** key.
* For title inputting method, refer to the section “**Entering titles**”.
8. Press the **[A-M]** button to change into the STANDARD display.

Professional mode/VSE operations

Note:

- The adjustment made in professional mode is not reflected in the adjustment in standard mode. On the contrary, the adjustment made in standard mode is not reflected in the adjustment in professional mode.

VSE effect ON/OFF

* The factory default setting is “ON”.

1. Press the **[A-M]** button to show the AUDIO-MODE display.
2. Touch the **[VSE ON/OFF]** key to select “on” and “off”.
3. Each time the **[ON/OFF]** key is touched, the on and off statuses are switched alternately.

DSP operations

- After the setting, press the **[A-M]** button again or touch the **[RTN]** key to return to the STANDARD display.

Note:

- If the VSE effect is set to OFF, the adjustment made in "VSE operations" is not reflected in the music source.

Calling VSE BASIC Pattern/USER Pattern

- Press the **[A-M]** button to show the AUDIO-MODE display.
- Touch the **[VSE BASIC]** and **[VSE USER]** key to show BASIC pattern selecting display or USER pattern selection/memory display.
- In the pattern selecting display, touch the one of pattern key to call corresponding VSE pattern.

In this display, pressing the No. button in corresponding to the **[DIRECT]** key can also call the VSE pattern.

- * After selecting the VSE pattern, touch the **[MEMO]** key to copy the selected pattern to the USER pattern.
 - * Touch the **[EDIT]** key to show VSE adjusting display, in which the properties of currently selected pattern can be adjusted.
 - * By pressing the **[BAND]** button in BASIC pattern selecting display or USER pattern selection/memory display you can switch between the two patterns, BASIC and USER.
- After the selecting, press the **[A-M]** button again or touch the **[RTN]** key two times to return to the STANDARD display.

Setting and storing VSE Properties/Memory into USER Pattern

- Repeat the steps 1 and 2 of the previous procedure (Calling VSE BASIC Pattern/USER pattern) to show BASIC pattern selecting display or USER pattern selection/memory display.
- Touch the **[EDIT]** key to show the VSE adjusting display.
- Select an item to be adjusted by touching **[ITEM]** key in the VSE adjusting display.

The VSE adjustment contents are as follows:

● "CAR LENGTH"

Compensates for the length of the car's interior (longitudinal direction).

● "CAR WIDTH"

Compensates for the width of the car's interior (lateral direction).

● "DIFFUSE"

Compensates for special impression.

- Touch the **[▲]** or **[▼]** key to make the adjustment.
The adjustment range is to 1 to 10 for each time.
- After making adjustments to a desired pattern by repeating the steps 3 and 4, touch the **[RTN]** key to change over to the BASIC/USER pattern selection/memory display.
- Press and hold one of **[DIRECT]** button for 2 seconds or longer to store the adjusted VSE pattern to the USER memory.
- To set a title of the stored USER pattern, touch the **[TITLE]** key to change into the **[TITLE INPUT]** key.
* For title inputting method, refer to the section "Entering titles".
- Press the **[A-M]** button to change into the STANDARD display.

Professional mode/P.EQ operations

P.EQ effect ON/OFF

- * The factory default setting is "ON".

- Press the **[A-M]** button to show the AUDIO-MODE display.
- Touch the **[P.EQ ON/OFF]** key to select "on" and "off".
- Each time the **[ON/OFF]** key is touched, the on and off statuses are switched alternately.
- After the setting, press the **[A-M]** button again or touch the **[RTN]** key to return to the STANDARD display.

Note:

- If the P.EQ effect is set to OFF, the adjustment made in "P.EQ operations" is not reflected in the music source.

DSP operations

Calling P.EQ BASIC Pattern/USER Pattern

1. Press the **[A-M]** button to show the AUDIO-MODE display.
2. Touch the **[▼]** key to select "**P.EQ BASIC**" and "**P.EQ USER**" mode.
Touch the **[P.EQ BASIC]** and **[P.EQ USER]** key to show BASIC pattern selecting display or USER pattern selection/memory display.
3. In the pattern selecting display, touch the one of pattern key to call corresponding P.EQ pattern. In this display, pressing the No. button in corresponding to the **[DIRECT]** key can also call the P.EQ pattern.
 - * After selecting the P.EQ Pattern, touch the **[MEMO]** key to copy the select pattern to the USER pattern.
 - * Touch the **[EDIT]** key to show P.EQ adjusting display, in which the properties of currently selected pattern can be adjusted.
 - * By pressing the **[BAND]** button in BASIC pattern selecting display or USER pattern selection/memory display you can switch between the two patterns, BASIC and USER.
4. After the selecting, press the **[A-M]** button again or touch the **[RTN]** key two times to return to the STANDARD display.

Setting and storing P.EQ Properties/ Memory into USER Pattern

1. In the Basic adjustment display or in the User setting display, press the **[A-M]** button to show the AUDIO-MODE display.
2. Touch the **[EDIT]** key to show the P.EQ adjusting display.
3. Select an item to be adjusted by touching **[ITEM]** key in the P.EQ adjusting display.
4. Touch the **[ITEM]** key to set each adjusting value.
The P.EQ adjustment contents are as follows:
 - "**FRONT/REAR**"
 - "**BAND**"
Select the channel to be compensated (front or rear).
 - "**FREQUENCY**"
Select the center frequency that you want to compensate from the range of 20 Hz to 20 kHz. (1/3 octave step, 31 points)

- "**GAIN**"

Adjust the gain (output level) in the range of -12 dB to +12 dB. (1 dB step, 25 points)

- "**Q**"

Set the sharpness of the Q-curve to one of the parameters: 1, 3, 5, 7 and 20.

5. After making adjustments to a desired pattern by repeating the operations of items 3 and 4, touch the **[RTN]** key to change over to the BASIC/USER pattern selection/memory display.
6. Press and hold one of **[DIRECT]** button for 2 seconds or longer to store the adjusted P.EQ pattern to the USER memory.
7. To set a title of the stored USER pattern, touch the **[TITLE]** key to change into the **[TITLE INPUT]** key.
 - * For title inputting method, refer to the section "**Entering titles**".
8. Press the **[A-M]** button to change into the STANDARD display.

DVD deck (video) functions

When an optional DVD deck (DVS9755z) is connected through the CeNET cable.

In this case, this unit only provides a part of the DVD deck functions. As for other operations not written in this manual, operates with a remote control unit provided with your DVD deck. Refer to the DVD deck owners' manual for details.

Press the **[FUNC]** button and select the DVD deck (video) mode to start play.

* If "NO DISC" appears in the display, insert a disc into the DVD deck.

Play/Still

Pressing and holding the **[▶/||]** button for about 1 second or longer switches to the desired mode (play, still (pause)).

Each time the button is pressed and held for about 1 second or longer, the mode is switched sequentially.

When the **[▶▶]** button is kept pressed during the still mode, slow play (1/2 play) is performed so far as the button is pressed.

Chapter up/down (FF/FB)

Press the right side of **[SEARCH]** button for 1 second or shorter to increment chapters.

Hold down the right side of **[SEARCH]** button for 1 second or longer to fast forward.

Press the left side of **[SEARCH]** button for 1 second or shorter to decrement chapters.

Hold down the left side of **[SEARCH]** button for 1 to fast backward.

Woofers level adjustment

You can adjust an output sound level of subwoofer.

1. Press the **[A-M]** button to show the AUDIO-MODE display.
2. Touch the **[WOOFER VOL]** key to show the woofer level adjusting display.
3. Touch the **[▲]** or **[▼]** key to adjust the level (-6 to +3)
4. After adjustment, touch the **[RTN]** key to return to the STANDARD display.

Center level adjustment

You can adjust an output sound level of center speaker.

1. Press the **[A-M]** button to show the AUDIO-MODE display.
2. Touch the **[CENTER VOL]** key to show the center level adjusting display.
3. Touch the **[▲]** or **[▼]** key to adjust the level (0 to -6)
4. After adjustment, touch the **[RTN]** key to return to the STANDARD display.

Adjusting the balance and fader

1. Press the **[A-M]** button to change into the AUDIO-MODE display.
2. Touch the **[BAL/FAD]** key when the AUDIO-MODE screen is being displayed to show the BALANCE/FADER adjustment screen.
3. Touch the **[▶]** or **[◀]** key to adjust to the desirable balance.
Adjusting range of the balance: left 13 to right 13
4. Touch the **[▲]** or **[▼]** key to adjust to the desirable fader.
Adjusting range of the fader: front 12 / rear 12
5. When adjustment is finished, touch the **[RTN]** key on the BALANCE/FADER adjustment screen to return to the AUDIO-MODE screen.

Touch the **[RTN]** key on the AUDIO-MODE screen to return to the STANDARD display.

* To return from the BALANCE/FADER mode display to the STANDARD display, press the **[A-M]** button once again.

* A DVD changer can not be connected along with this unit.

11. IN CASE OF DIFFICULTY

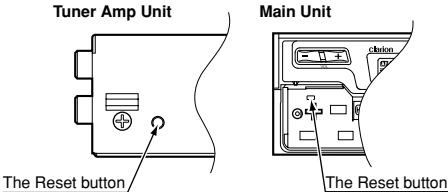
	Problem	Cause	Measure
GENERAL	Power does not turn on. (No sound is produced.)	Fuse is blown.	Replace with a fuse of the same amperage. If the fuse blows again, consult your store of purchase.
		Incorrect wiring.	Consult your store of purchase.
	Nothing happens when buttons are pressed. Display is not accurate.	The microprocessor has malfunctioned due to noise, etc.	Turn off the power, then press the [RELEASE] lever and remove the DCP. Press the reset button for about 2 seconds with a thin rod.
			 <p>The Reset button</p> <p>The Reset button</p>
	The remote controller does not work.	Direct rays of the sun fall on the light-receptive part of the remote controller.	When direct rays of the sun fall on the light-receptive part of the remote controller, it may not work.
The batteries of the remote controller unit are dead or there is no battery in the remote controller unit.		Check the batteries of the remote controller unit.	
CD	Compact disc cannot be loaded.	Another compact disc is already loaded.	Eject the compact disc before loading the new one.
		There is a disc other than a CD or foreign matter already in place.	The foreign matter is forcibly ejected.
	Sound skips or is noisy.	Compact disc is dirty.	Clean the compact disc with a soft cloth.
		Compact disc is heavily scratched or warped.	Replace with a compact disc with no scratches.
	Sound is bad directly after power is turned on.	Water droplets may form on the internal lens when the car is parked in a humid place.	Let dry for about 1 hour with the power on.

	Problem	Cause	Measure
TV	The image is not displayed.	The parking brake is not pulled.	Check that the parking brake is applied.
	The display is dark.	The brightness control is too low.	Adjust the brightness properly.
		The operating condition is not good.	The temperature inside the vehicle may be 0°C or less. Set to an appropriate temperature (25°C or so) and check it again.
		The headlight of the vehicle is lit.	The display is made dark at night to prevent the glare (When the headlight of the vehicle is lit in the daytime, the display gets dark).
	The color of the display is light or a shade of color is not good.	The color is not adjusted adequately.	Check that COL and HUE are adjusted properly.
	When the VTR is connected, the image is disturbed.	Improper NTSC/PAL setting	Set the NTSC/PAL properly according to the VTR.
	When the TV tuner is connected, the image gets unclear.	Bad receiving condition	A radio wave may not reach sufficiently due to obstruction of mountains or buildings. Check it again at a place where a radio wave can be received properly.
	The TV tuner has a double or triple image.	Bad receiving condition	It may be under the influence of radio wave reflected by mountains or buildings. Check it again after changing place or direction.
The TV tuner has spots or stripes in the image.	Presence of jamming	It may be under the influence from automobiles, streetcar, power cable, neon sign, and so forth. Check it again after changing place.	
There are red, green, and blue points in the display.	_____	This is not a failure, but a phenomenon peculiar to a liquid crystal panel (The LCD panel is produced according to technology with very high precision. Note that, though there are effective pixels of 99.99% or more, pixel missing or normally lit pixels account for 0.01%).	

12. ERROR DISPLAYS

If an error occurs, one of the following displays is displayed. Take the measures described to eliminate the problem.

	Error Display	Cause	Measure
CD	ERROR 2	A CD is caught inside the CD deck and is not ejected.	This is a failure of CD deck's mechanism and consult your store of purchase.
	ERROR 3	A CD cannot be played due to scratches, etc.	Replace with a non-scratched, non-warped-disc.
	ERROR 6	A CD is loaded upside-down inside the CD deck and does not play.	Eject the disc then reload it properly.
CD CHANGER	ERROR 2	A CD inside the CD changer is not loaded.	This is a failure of CD changer's mechanism and consult your store of purchase.
	ERROR 3	A CD inside the CD changer cannot be played due to scratches, etc.	Replace with a non-scratched, non-warped-disc.
	ERROR 6	A CD inside the CD changer cannot be played because it is loaded upside-down.	Eject the disc then reload it properly.
MD CHANGER	ERROR H	Displayed when the temperature in the MD changer is too high and playback has been stopped automatically.	Lower the surrounding temperature and wait for a while to cool off MD changer.
	ERROR 2	An MD inside the MD changer is not loaded.	This is a failure of MD changer's mechanism and consult your store of purchase.
	ERROR 3	An MD inside the MD changer cannot be played due to scratches, etc.	Replace with a non-scratched, non-warped-disc.
	ERROR 6	An MD inside the MD changer cannot be played because it is loaded upside-down.	Eject the disc then reload it properly.
		Displayed when a non-recorded MD is loaded in the MD changer.	Load a pre-recorded MD in the MD changer.

- If an error display other than the ones described above appears, press the RESET button. If the problem persists, turn off the power and consult your store of purchase.
- For the DVD changer, refer to the Owner's Manual provided with the DVD changer.

13. SPECIFICATIONS

FM Tuner

Frequency Range: 87.50 MHz to 108.00 MHz
Usable Sensitivity: 11 dBf
50dB Quieting Sensitivity: 17 dBf
Alternate Channel Selectivity: 75 dB
Stereo Separation(1 kHz): 35 dB
Frequency Response(± 3 dB): 30 Hz to 15 kHz

AM Tuner

Frequency Range: 531 kHz to 1629 kHz
Usable Sensitivity: 25 μ V

CD player

System: Compact disc digital audio system
Frequency Response: 17 Hz to 20 kHz (± 1 dB)
Signal to Noise Ratio: 98 dB (1 kHz) IHF-A
Dynamic Range: 95 dB (1 kHz)
Distortion: 0.02%

Audio Amplifier

Rated power output:
17 W \times 4 (20 Hz to 20 kHz, 1%, 4 Ω)
Maximum power output:
192 W (48 W \times 4)
Speaker impedance: 4 Ω (4 to 8 Ω)

Input

Audio input:
130 \pm 60mVrms (input impedance 10k Ω or greater)
Video input:
1.0 \pm 0.2 Vp-p (input impedance 75 Ω)

Video output

Video output:
1.0 \pm 0.2 Vp-p (output impedance 75 Ω)

LCD Monitor

Screen Size: 7-inch wide type
152 (Width) \times 85 (Height) mm
Display method:
Transmission type TN liquid crystal display
Drive method: TFT (thin-film transistor)
active matrix driving
Pixels: 336,960 (1440 \times 234)

General

Power source voltage:
14.4 V DC (10.8 to 15.6 V allowable)
Ground: Negative
Current consumption: 4.0 A (1 W)
Auto Antenna Rated Current: 500 mA less
Dimensions of the Main Unit:
178 (Width) \times 50 (Height) \times 165 (Depth) mm
Dimensions of the Tuner Amp Unit:
178 (Width) \times 37.5 (Height) \times 209.5 (Depth) mm
Weight of the Main Unit: 2.0 kg
Weight of the Tuner Amp Unit: 1.1kg
Dimensions of the Remote Control Unit:
44 (Width) \times 110 (Height) \times 27 (Depth) mm
Weight of the Remote Control Unit:
30 g (including battery)

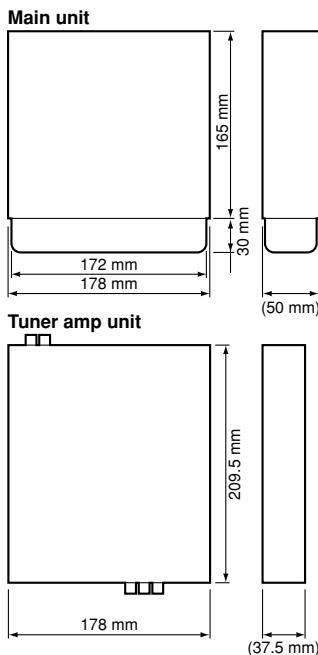

Notes:

- Specifications comply with JEITA Standards.
- Specifications and design are subject to change without notice for further improvement.

■ Contents

1. BEFORE STARTING	47
2. PACKAGE CONTENTS	47
3. GENERAL CAUTIONS	48
4. CAUTIONS ON INSTALLATION	48
5. INSTALLING THE MAIN UNIT	49
6. REMOVING THE MAIN UNIT	51
7. CAUTIONS ON WIRING	51
8. WIRE CONNECTION	52
9. SAMPLE SYSTEMS	55

1. BEFORE STARTING

1. This set is exclusively for use in cars with a negative ground 12 V power supply.
2. Read these instructions carefully.
3. Be sure to disconnect the battery “⊖” terminal before starting. This is to prevent short circuits during installation. (Figure 1)

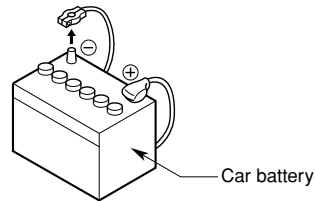

Figure 1

2. PACKAGE CONTENTS

- | | |
|--|---|
| <ul style="list-style-type: none"> ① Main unit ② Tuner Amp unit ③ Manuals
Owner's manual & Installation manual
Warranty card ④ Power supply lead (For the tuner amp unit) ⑤ Connection cord (Main unit ↔ Tuner amp unit) ⑥ Antenna extension cord ⑦ Bag for accessories of the main unit (No. 1)
Flat head screw (M5 × 8) 4
Sems hexagonal bolt (M5 × 8) 5
Electro tap
Machine screw (M4 × 3) 4 | <ul style="list-style-type: none"> ⑧ Bag for accessories of the main unit (No. 2)
Hook plate 2
Cord clamp
Spacer
Special screw ⑨ Bag for accessories of tuner amp unit
Mounting bracket 2
Canoe clip 4
Machine screw (M4 × 8) 4 ⑩ Universal mounting bracket ⑪ Remote control unit ⑫ Battery
(for remote control unit) ⑬ Outer Escutcheon ⑭ DCP Case |
|--|---|

3. GENERAL CAUTIONS

1. Do not open the case. There are no user serviceable parts inside. If you drop anything into the unit during installation, consult your dealer or an authorized CLARION service centre.
2. Use a soft, dry cloth to clean the case. Never use a rough cloth, thinner, benzine, or alcohol, etc. For tough dirt, apply a little cold or warm water to a soft cloth and wipe off the dirt gently.

4. CAUTIONS ON INSTALLATION

1. Prepare all articles necessary for installing the main unit before starting.
2. This model is used with the LCD panel slid forwards (shell loading system). On some types of cars, the LCD panel may touch the dashboard or shift lever, in which case it cannot be installed. Check that the set will not hamper operation of the shift lever before choosing the place of installation. (Figure 2)

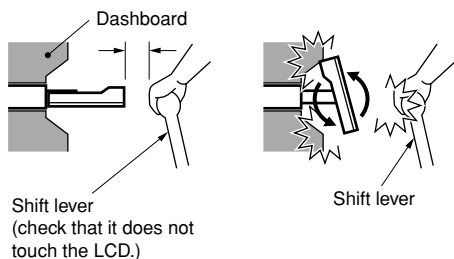

Figure 2

3. Install the unit within 30° of the horizontal plane. (Figure 3)

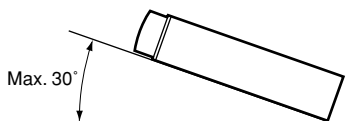

Figure 3

4. If you have to do any work on the car body, such as drilling holes, consult your car dealer beforehand.

5. Use the enclosed screws for installation. Using other screws can cause damage. (Figure 4)

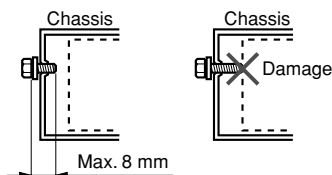

Figure 4

6. The source unit has mounting screw holes for NISSAN (N marks) and TOYOTA (T marks) vehicles.

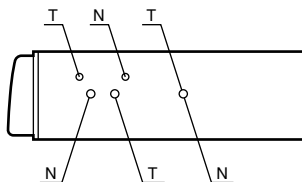

Figure 5

5. INSTALLING THE MAIN UNIT

■ Universal Mount

1. Place the universal mounting bracket into the instrument panel, use a screwdriver to bend each stopper of the universal mounting bracket inward, then secure the stopper as shown in Figure 6.
2. Wire as shown in Section 8.
3. Insert the main unit into the universal mounting bracket until it locks.
4. Mount the outer escutcheon so that all the hooks are locked.

Notes:

- 1) Some car models require special mounting kits for proper installation. Consult your Clarion dealer for details.
- 2) Fasten the front stopper securely to prevent the main unit from coming loose.

• Console opening dimensions

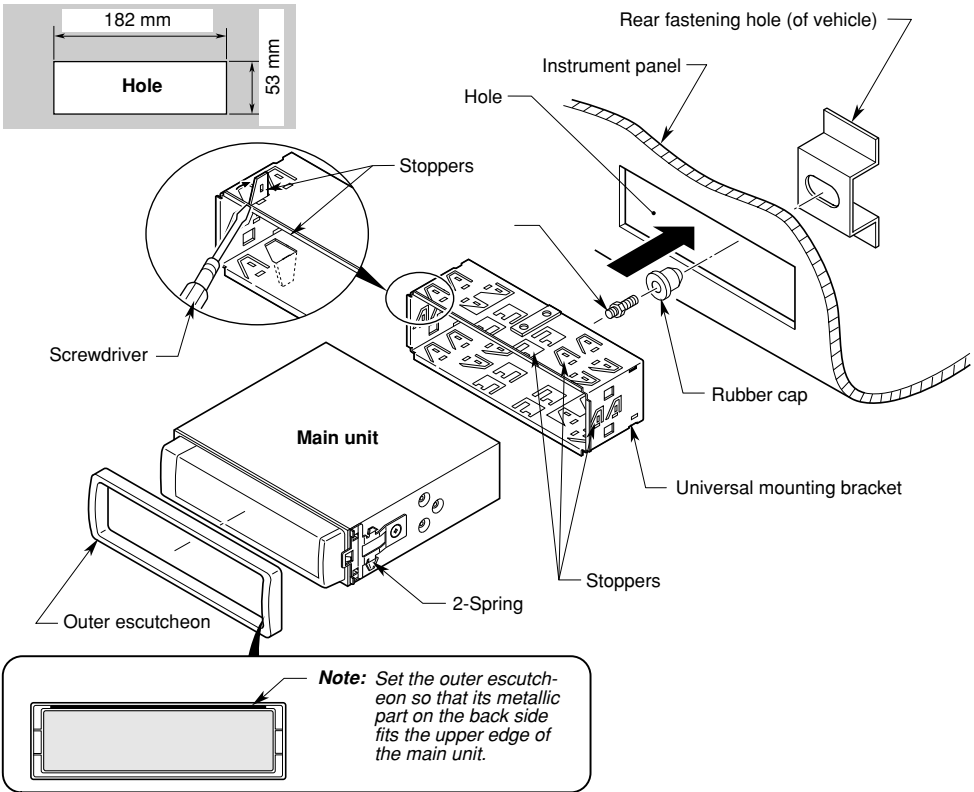
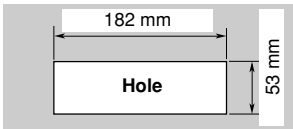

Figure 6

■ Fixed Mount (TOYOTA, NISSAN and other ISO/DIN equipped vehicles)

This unit is designed for fixed installation in the dashboard.

If the vehicle is equipped with a factory-installed radio, install the main unit with the parts and screws marked (*). (Figure 8)

If the vehicle is not equipped with a factory-installed radio, obtain an installation kit to install the main unit in the following procedure.

1. Remove the screws from both side of the main unit. Then, at either side, lift the leaf spring until the engaging claws are released from the holes, and slide the spring to the di-
2. Secure the mounting brackets to the chassis as shown in Figure 8. Holes are pre-tapped for TOYOTA and NISSAN vehicles; modification, such as drilling new holes, of the mounting brackets may be required for other models.
3. Wire as shown in Section 8.
4. Secure the unit in the dashboard, and then reassemble the dashboard and the centre panel.

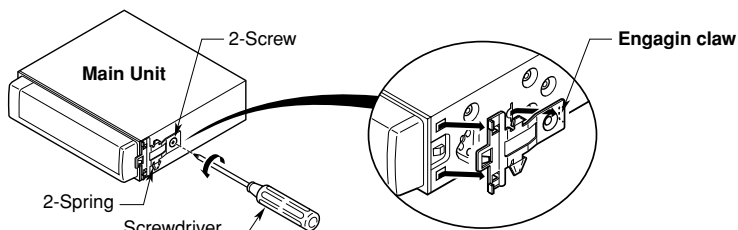

Figure 7

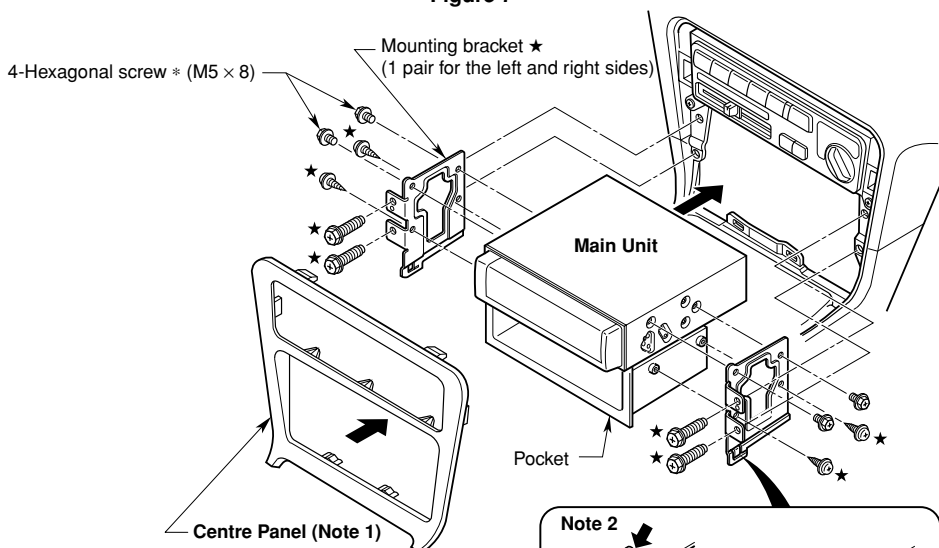

Figure 8

*: The screws with this mark are enclosed in this set.

★: The parts and screws with this mark are used to install radio or included in the installation kit.

Note 1: In some cases, the centre panel may require some modification (trimming, filling, etc.).

Note 2: If a hook on the installation bracket interferes with the unit, bend and flatten it with a nipper or a similar tool.

6. REMOVING THE MAIN UNIT

1. When the rear of the main unit has been secured with the method shown in Figure 6 unfasten the special screw.
2. Remove the outer escutcheon.
3. Insert the hook plate between the spring and the universal mounting bracket, fit tab **B** of the spring into hole **A** of the hook plate, then

pull the main unit out by the hook plate. (Insert both the right and left edges of the hook plate.) (Figure 9)

Note: Keep the hook plate. You cannot remove the main unit without disengaging the hook plate.

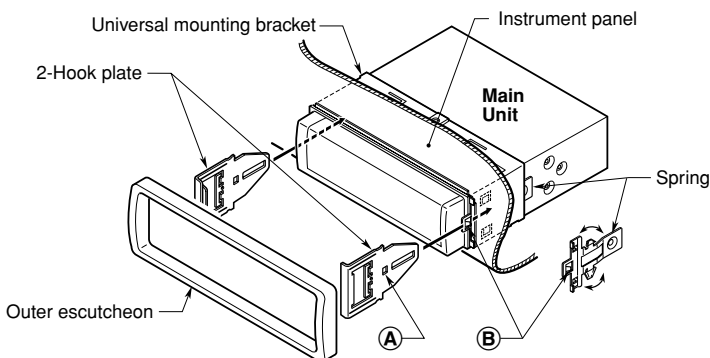

Figure 9

7. CAUTIONS ON WIRING

1. Be sure to turn the power off before wiring.
2. Be particularly careful where you route the wires.
Keep them well away from the engine, and exhaust pipe, etc. Heat may damage the wires.
3. If the fuse should blow, check to see if the wiring is correct.
If it is, replace the fuse with a new one with the same amperage rating as the original.
4. When any fuse is to be replaced, pull out the fuse (15A) at the rear of the tuner amp unit and put in a new one (Fig.10).

Rear view of the tuner amp unit

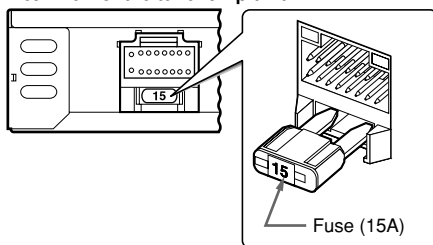

Figure 10

CAUTION

After the connection, fix the lead by a clamp or insulation tape for protection.

5. To replace the fuse, release the catch on the main unit side, remove the old fuse and insert the new one. (Figure 11)

Note: There are various types of fuse holder. Do not let the battery side touch other metal parts.

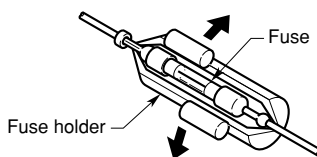
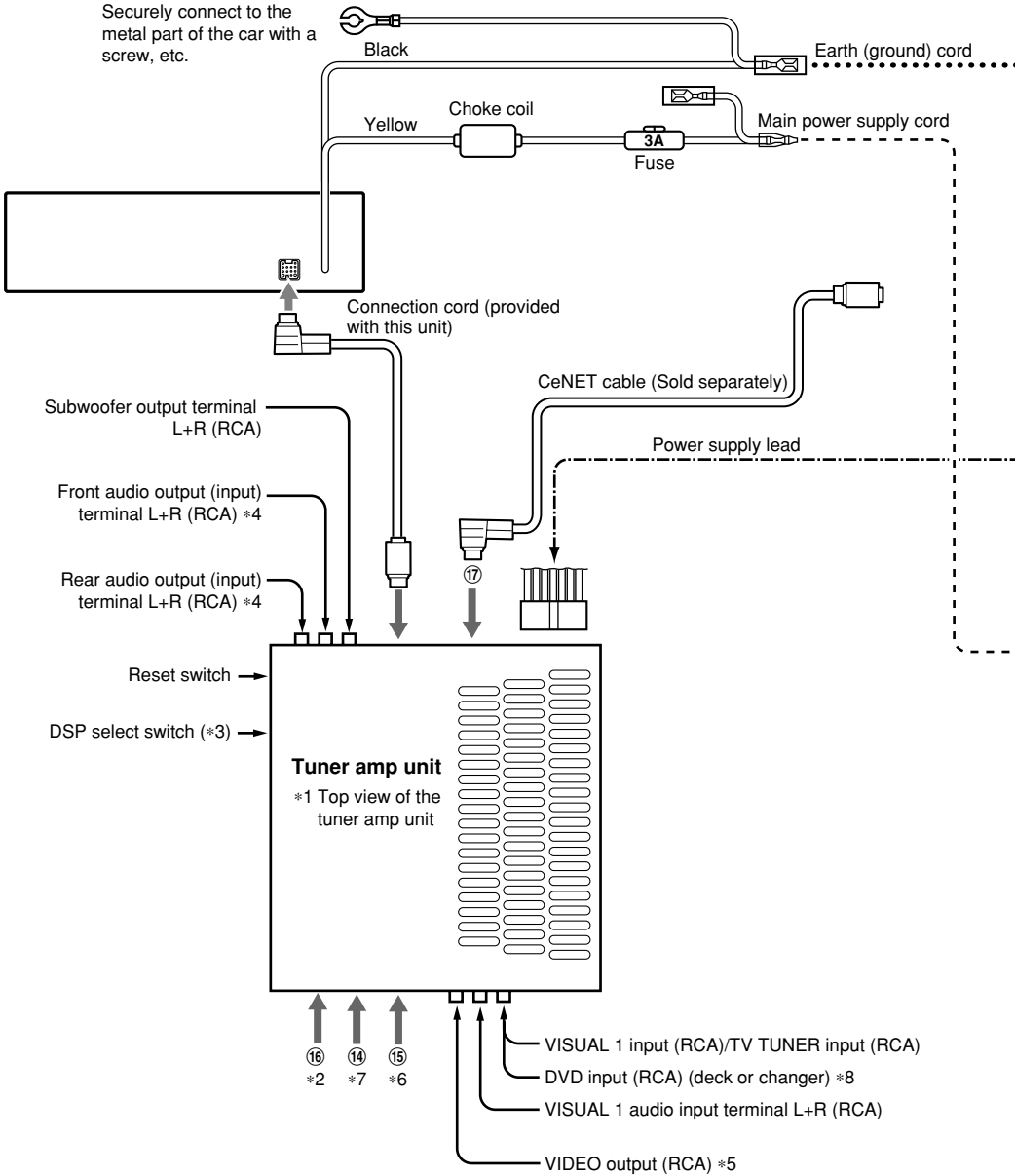
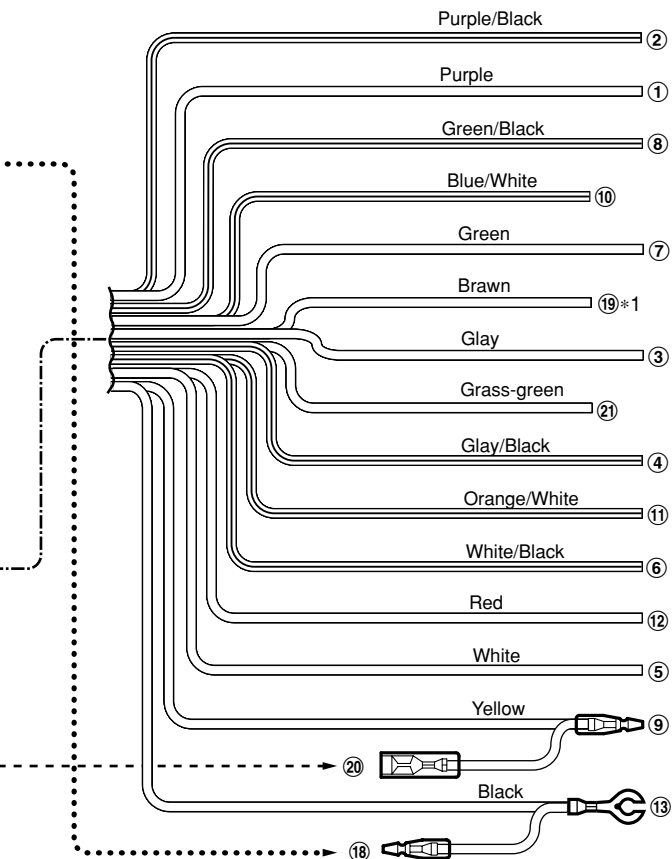

Figure 11

8. WIRE CONNECTION

Securely connect to the metal part of the car with a screw, etc.





No.	Description
①	REAR RIGHT⊕
②	REAR RIGHT⊖
③	FRONT RIGHT⊕
④	FRONT RIGHT⊖
⑤	FRONT LEFT⊕
⑥	FRONT LEFT⊖
⑦	REAR LEFT⊕
⑧	REAR LEFT⊖
⑨	+12 V MAIN POWER
⑩	AUTO ANTENNA
⑪	ILLUMINATION
⑫	+12 V ACCESSORY
⑬	GROUND
⑭	CCD/M.LOCK terminal
⑮	VISUAL 2 terminal
⑯	Radio antenna jack (*2)
⑰	CeNET terminal
⑱	Spare terminal (Black)
⑲	Phone mute (Brown) (*1)
⑳	Spare terminal (Yellow)
㉑	Parking brake (Grass-Green)

*1: Connecting the PHONE MUTE Terminal

The lead included with the unit must be connected to the specified position of the vehicle's connector in order to use the "triggered audio mute for cellular telephones" function.

*2: Use the attached extension lead when necessary. (Provided with this unit)

Note : Before making any installation, disconnect the car battery - (negative) cable.

*3: When a DSP (sold separately) is connected and the internal amp of the Tuner Amp Unit is used, set the DSP select switch to "D". Then, the AUDIO OUT (IN) terminal of the Tuner Amp Unit is only available for audio input, not outputting the audio.



*4: Connect to a separately sold external amplifier, DSP, etc. with a separately sold RCA cord (L,R).

*5: Connect to a separately sold Rear view monitor for the rear seat.

*6: Connect to separately sold VTR equipment.

*7: M. LOCK function is available only on this connection terminal.

*8: DVD deck and DVD changer can not be connected at the same time.

■ Connecting the Accessories

• Connection to the external amplifier

The external amplifier cannot be connected unless the DSP is connected. For detailed information, refer to the instruction manual of the DSP.

• Connection to the CCD camera for vehicle

The CCD camera for vehicle can be connected to the CCD terminal on the tuner amp unit. For detailed information, refer to the instruction sheet or manual for the CCD camera.

Notes:

- A power supply box (sold separately) is required for connection of the tuner amp unit and the CCD camera.
 - While the CCD camera is used, the navigation cannot be turned on.
 - The power supply box for camera CAA147 cannot be used. Please use the CAA188 instead.
- **If the specified lead of the cellular phone is connected to the phone mute lead of the source unit, the audio mute is available when the cellular telephone is used.**

• TV Tuner

When the TV TUNER is to be connected, connect the CeNET connector and RCA PIN (yellow). For detailed information, refer to the instruction manual of the TV TUNER.

■ Connecting the parking brake lead

Connect the lead to parking brake lamp earth in the meter panel.

Notes:

- Connecting the parking brake lead to lamp earth allows you to watch TV/VTR/DVD video/DVD changer when the parking brake is engaged.
- When the parking brake lead is not connected, the monitor will stay off.

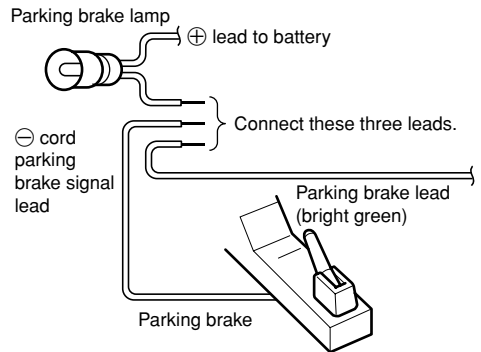

9. SAMPLE SYSTEMS

■ Sample System 1

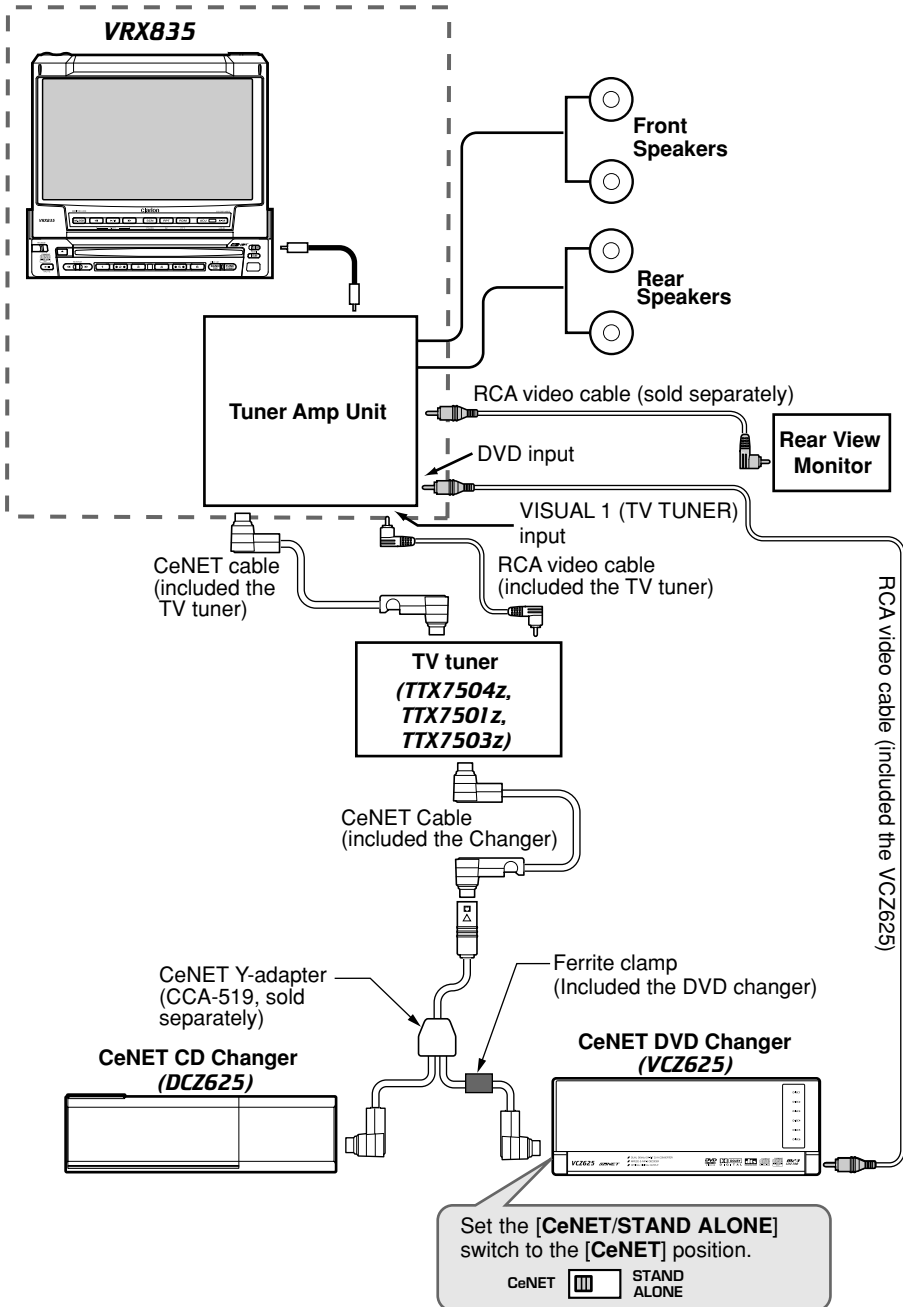

■ Sample System 2

